

Safety Information

Important Safety Information

This owner's guide includes information for Regulatory Model(s): RVD-Y1

SAVE THESE INSTRUCTIONS

 **WARNING:** When using an electrical appliance, basic precautions should always be followed, including the following:

READ ALL INSTRUCTIONS

 **WARNING:** To reduce the risk of injury or damage, read and follow the safety precautions when setting up, using, and maintaining your robot.

This appliance can be used by children aged from 8 years and above and persons with reduced physical, sensory, or mental capabilities or lack of experience and knowledge if they have been given supervision or instruction concerning use of the appliance in a safe way and understand the hazards involved. Children shall not play with the appliance. Cleaning and user maintenance shall not be made by children without supervision.

 This is the safety alert symbol. It is used to alert you to potential physical injury hazards. Obey all safety messages that follow this symbol to avoid possible injury or death.

 Risk of electric shock

 Class II equipment

 Rated power output, d.c.

 Read operator's manual

 General symbol for recycling

 Risk of fire

 For indoor use only

 Rated power input, d.c.

 Keep out of reach of children

 Rated power input, a.c.

 Separate Supply Unit

WARNING: Indicates a hazardous situation that, if not avoided, could result in death or serious injury.

CAUTION: Indicates a hazardous situation that, if not avoided, could result in minor or moderate injury.

NOTICE: Indicates a hazardous situation that, if not avoided, could result in property damage.

GENERAL



WARNING



- Your robot is not a toy. Small children and pets should be supervised when your robot is operating.
- Do not sit or stand on your robot or Home Base.
- Do not use unauthorised chargers. Use of an unauthorised charger could cause the battery to generate heat, smoke, catch fire, or explode.
- Your robot comes with a region approved power supply cord and is designed to be plugged into a standard household AC power socket only. Do not use any other power supply cord. For replacement cords, please contact Customer Care to ensure proper selection of country specific power supply cord.
- Do not open your robot or Home Base. There are no user serviceable parts inside. Refer servicing to qualified service personnel.
- Risk of electric shock, use indoors in dry locations only.
- Do not handle your robot or Home Base with wet hands.
- Store and operate your robot in room temperature environments only.
- If the room to be cleaned contains a balcony, a physical barrier should be used to prevent access to the balcony and ensure safe operation.
- Clean cliff sensors to remove buildup.



CAUTION



- Do not operate the robot in areas with exposed electrical sockets in the floor.
- If the device passes over a power cord and drags it, there is a chance an object could be pulled off a table or shelf. Before using this device, pick up objects like clothing, loose papers, pull cords for blinds or curtains, power cords, and any fragile objects.
- Be aware that the robot moves on its own. Take care when walking in the area that the robot is operating in to avoid stepping on it.
- Do not use this device to pick up sharp objects, glass, or anything that is burning or smoking.

NOTICE

- This robot is intended for dry floor use only. Do not use this device to pick up spills. Do not allow your robot or Home Base to become wet.
- Do not place anything on top of your robot.
- The failure to maintain cleanliness of charger contacts could result in loss of ability for the robot to charge the battery.

HOME BASE



WARNING



- Do not use a Home Base with a damaged cord or plug. If the cord or plug is damaged, it must be replaced.
- Always disconnect your robot from the Home Base before cleaning or maintaining it.
- Charge your robot only with the power supply provided. The provided power supply delivers safety extra low voltage corresponding to the input marking on the robot which is required to maintain safe operation.

- To prevent the risk of your robot falling down stairs, ensure that the Home Base is placed at least 4 feet (1.2 metres) away from stairs.

NOTICE

- Product may not be used with any type of power converter. Use of power converters will immediately void the warranty.
- If you live in an area prone to electrical storms, it is recommended that you use additional surge protection. Your Home Base may be protected with a surge protector in the event of severe electrical storms.

BATTERY



WARNING



- Do not open, crush, or heat above 176°F: 80°C, or incinerate. Follow the manufacturer's instructions.
- Do not short-circuit the battery by allowing metal objects to contact battery terminals or immerse in liquid. Do not subject batteries to mechanical shock.
- Periodically inspect the battery pack for any sign of damage or leakage. Do not charge damaged or leaking battery packs, do not allow the liquid to come in contact with skin or eyes. If contact has been made, wash the affected area with copious amounts of water and seek medical advice. Place the battery in a sealed plastic bag and recycle or dispose of it safely according to local environmental regulations, or return it to your local authorised iRobot Service Center for disposal.
- Lithium ion batteries and products that contain lithium ion batteries are subject to stringent transportation regulations. If you need to ship this product (with the battery included) for service, travel, or any other reason, you **MUST** see the Troubleshooting section of your manual or contact customer care for shipping instructions.



CAUTION



- Battery usage by children should be supervised. Seek medical advice immediately if a cell or a battery has been swallowed.

NOTICE

- The battery pack must be removed from the robot before recycling or disposal.
- For best results, only use the iRobot Lithium Ion Battery that comes with the robot.
- Do not use non-rechargeable batteries. Use only the rechargeable battery supplied with the product. For replacement, purchase identical iRobot battery or contact iRobot Customer Care for alternative battery options.
- Always charge and remove the battery from your robot and accessories before long-term storage.



This symbol on the battery indicates that the battery must not be disposed of with unsorted common municipal waste. As the end-user, it is your responsibility to dispose of the end-of-life battery in your appliance in an environmentally sensitive manner as follows:

- (1) returning it to the distributor/dealer from whom you purchased the product; or
- (2) depositing it in a designated collection point

The separate collection and recycling of end-of-life batteries at the time of disposal will help to conserve natural resources and to ensure that it is recycled in a manner that protects human health and the environment. For more information, please contact your local recycling office or the dealer from whom you originally purchased the product. Failure to properly dispose of end-of-life batteries may potentially result in negative effects on the environment and human health due to the substances in the batteries and accumulators.

Information regarding the effects of problematic substances in the battery waste stream may be found at the following source:
<http://ec.europa.eu/environment/waste/batteries/>

About your Roomba® Robot Vacuum

Top View

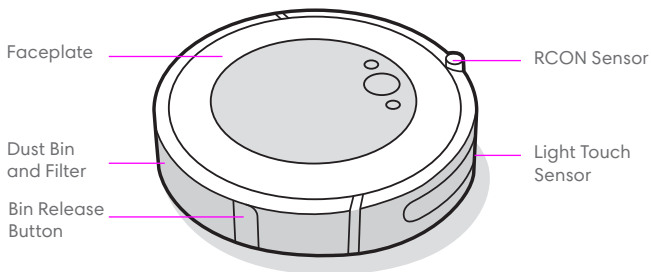

Bottom View

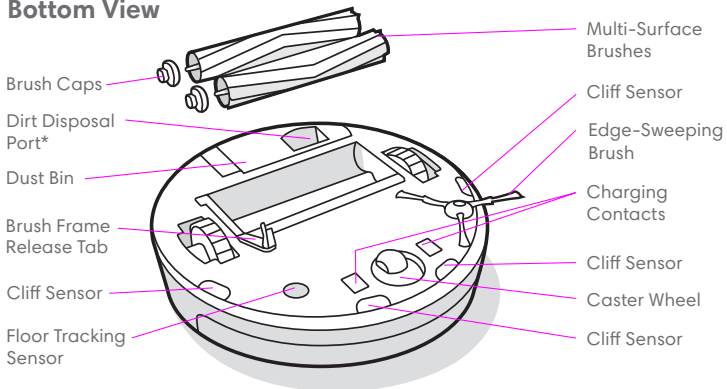

*Selected models only

Home Base Charging Station

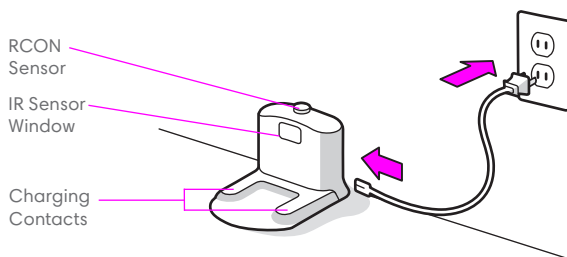

Buttons & Indicators

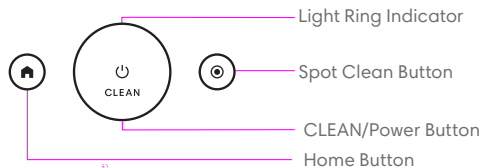

Using Your Roomba® Robot Vacuum

Positioning the Home Base Charging Station

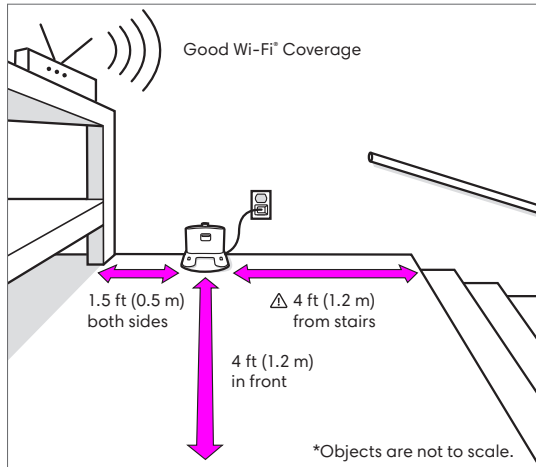

⚠ WARNING: To prevent the risk of your robot falling down stairs when it is leaving or returning to the Home Base, ensure that the Home Base is placed at least 4 feet (1.2 metres) away from stairs.

Download the iRobot HOME App and connect to Wi-Fi®

- Follow step-by-step instructions to set up your Roomba.
- Set an automatic cleaning schedule and customise your cleaning preferences.
- Access to tips, tricks, and answers to commonly asked questions.



Charging

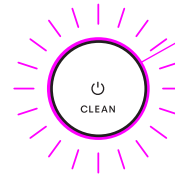

White Light Ring While Charging

Solid White: fully charged

Pulsing White: charging

Pulsing Red: charging/low

- Place the robot on the Home Base to activate the battery.



Note: Your robot comes with a partial charge, but we recommend that you charge the robot for 3 hours prior to starting the first cleaning job.

- If your robot needs to recharge mid-clean, it will return to its Home Base. Once it is sufficiently charged, it will then resume the cleaning job where it left off.
- The robot uses a small amount of power whenever it is on the Home Base. You can put the robot in a further-reduced power state when not in use. For instructions and more details on this Reduced Power Standby Mode, refer to the iRobot HOME App.
- For long-term storage, turn off the robot by removing it from the Home Base and holding down  for 10 seconds. Store the robot in a cool, dry place.

Cleaning



Remove excess clutter from floors before cleaning. Use your robot frequently to maintain well-conditioned floors.

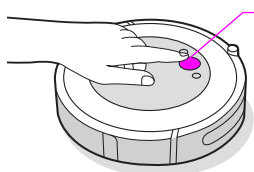

Just Press CLEAN

Tap to Start/Pause/Resume

Hold for 3 seconds to end a job

- Your robot will automatically explore and clean your home. It will return to the Home Base at the end of a cleaning job and whenever it needs to recharge.
- To send the robot back to its Home Base, tap . A blue light ring pattern will indicate that the robot is seeking the Home Base.
- When your robot detects an especially dirty area, it will go into Dirt Detect™ mode, moving over the area multiple times until it senses that the area has been sufficiently cleaned. The light ring indicator will flash blue.
- Tap to spot clean a designated area. The robot will spiral outward about 3 feet (1 metre) and then spiral inward to end where it started. The light ring indicator will show a blue spiral.

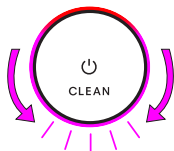

When the robot senses its bin needs to be emptied, the light ring indicator will illuminate in a red sweeping motion toward the rear.

Troubleshooting

- Your robot will tell you something is wrong by playing an audio alert and turning the light ring indicator red. Press CLEAN for details. Further support and instructional videos are available in the iRobot HOME App.

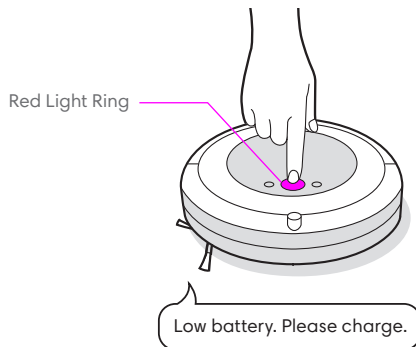

- If you are unsure if the robot is finished or paused, consult the iRobot HOME App to check on its status.

Battery Safety & Shipping

For best results, only use the iRobot Lithium Ion Battery that comes with your robot.

WARNING: Lithium ion batteries and products that contain lithium ion batteries are subject to stringent transportation regulations. If you need to ship this product for service, travel or any other reason, you **MUST** follow the below shipping instructions.

- Battery **MUST** be turned off before shipping.
- Turn off the battery by removing the robot from the Home Base and holding down for 10 seconds. All indicators will turn off.
- Package the robot securely for shipping.
- If you need further assistance, contact our Customer Care team or visit global.irobot.com.

Accessories

Dual Mode Virtual Wall® Barrier*

Note: For best results, place at least 8 feet (2.5 metres) from the Home Base.

Use the Dual Mode Virtual Wall® barrier to keep the robot in the places you want cleaned — and out of the ones you don't. It creates an invisible barrier that only the robot can see. You can leave the device in position between cleanings.

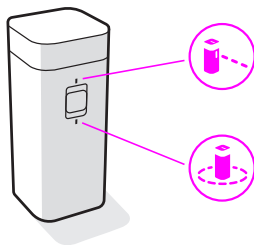

*Dual Mode Virtual Wall included for selected models only

Choose the mode to meet your needs:

Virtual Wall Mode: When the switch is in the Virtual Wall position (🚧), the device will create a linear barrier to block openings up to 10 feet (3 metres).

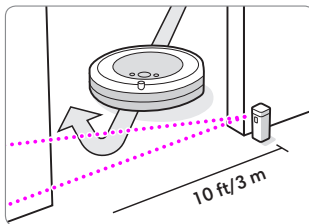

Note: This barrier gets wider as it gets further from the device (refer to illustration).

Halo Mode: Toggle the switch to the Halo position (🌊), to create a circular barrier. This will prevent the robot from approaching zones you want to protect such as a pet bowl, vase, or under a desk. The Halo barrier extends approximately 12 inches (30 centimetres) from the centre of the device.

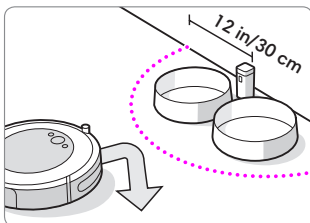

Note: The batteries will last about 8–10 months under normal use. If you are not planning to use your Virtual Wall barrier for an extended period of time, be sure to turn the switch to the Off, or middle position.

EN

Care and Maintenance

Care and Maintenance Instructions

To keep your robot running at peak performance, perform the procedures on the following pages.

There are additional instructional videos in the iRobot HOME App. If you notice the robot picking up less debris from your floor, empty the bin, clean the brushes, and clean or replace the filter if needed.

Part	Care Frequency	Replacement Frequency*
Bin	Wash bin as needed	
Filter	Clean once a week (twice a week if you have a pet). Do not wash.	Every 2 months
Full Bin Sensor	Clean every 2 weeks	
Front Caster Wheel	Clean every 2 weeks	Every 12 months
Edge-Sweeping Brush and Multi-Surface Brushes	Clean once a month (twice a month if you have a pet)	Every 12 months
Sensors and Charging Contacts	Clean once a month	

Note: iRobot manufactures various replacement parts and assemblies. If you think you need a replacement part, please contact iRobot Customer Care for more information.

*Replacement frequency may vary. Parts should be replaced if visible wear appears.

Emptying the Bin

- 1 Press the bin release button to remove bin.

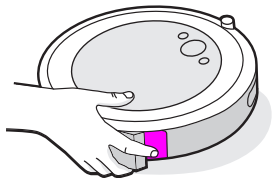

- 2 Open bin door to empty bin.

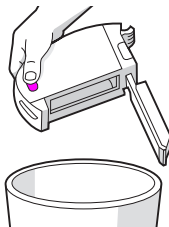

- 3 Place bin back in the robot.

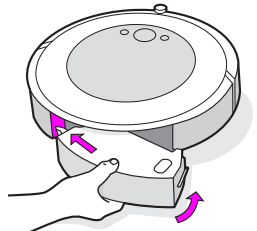

Cleaning the Filter

- 1 Remove the bin. Remove the filter by grasping both ends and pulling out.

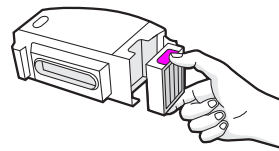

- 2 Remove debris by tapping the filter against your rubbish bin.



- 3 Reinsert filter with ridged grips facing out. Place bin back in the robot.

Important: The robot will not run if the filter is not installed correctly. Replace the filter every two months.

Cleaning the Full Bin Sensors

- 1 Remove and empty the bin.

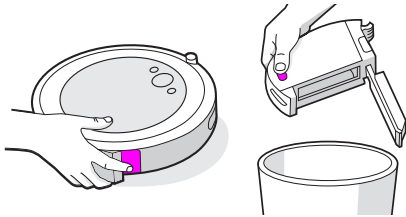

- 2 Wipe the inner sensors with a clean, dry cloth

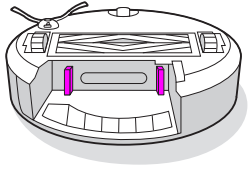

- 3 Wipe the bin door with a clean, dry cloth.

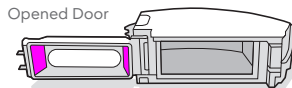
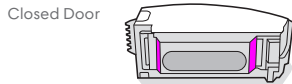

Washing the Bin

-  **Important:** Do not wash the filter. Remove the filter before washing the bin.

- 1 Release the bin, remove the filter, and open the bin door.
- 2 Rinse the bin using warm water.

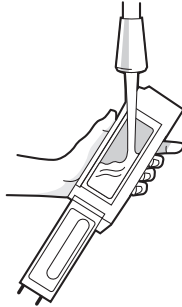

-  **Note:** Bin is not dishwasher safe.

- 3 Make sure the bin is completely dry. Reinsert filter and place bin back in the robot.

Cleaning the Edge-Sweeping Brush

- 1 Use a small screwdriver to loosen the screw holding the Edge-Sweeping Brush in place.
- 2 Pull to remove the Edge-Sweeping Brush. Remove any hair or debris, then reinstall the brush.

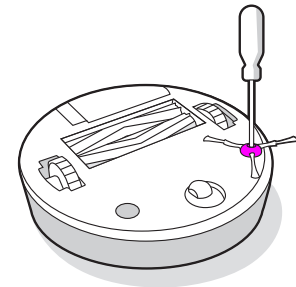

Cleaning the Front Caster Wheel

- 1 Pull firmly on the front wheel module to remove it from the robot.
- 2 Pull firmly on the wheel to remove it from its housing (see illustration below).
- 3 Remove any debris from inside the wheel cavity.
- 4 Reinstall all parts when finished. Make sure the wheel clicks back into place.

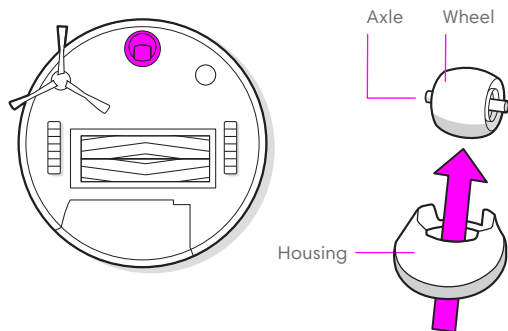

*** Important:** A front wheel clogged with hair and debris could result in damage to your floor. If the wheel is not spinning freely after you have cleaned it, please contact Customer Care.

Cleaning the Multi-Surface Brushes

- 1 Pinch the brush frame release tab, lift the tab, and remove any obstructions.
- 2 Remove the brushes from the robot. Remove the brush caps from the ends of the brushes. Remove any hair or debris that has collected beneath the caps. Reinstall the brush caps.
- 3 Remove any hair or debris from the square and hexagonal pegs on the opposite side of the brushes.
- 4 Remove the bin from the robot and clear any debris from the vacuum path.
- 5 Reinstall the brushes in the robot. Match the shape of the brush pegs with the shape of the brush icons in the cleaning head module.

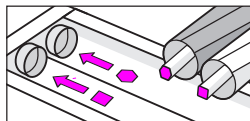
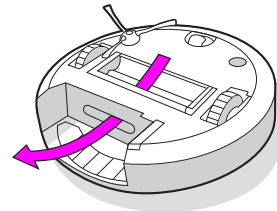
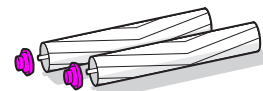
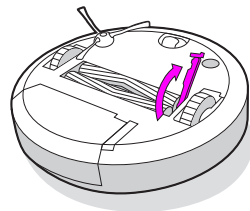

Cleaning the Sensors and Charging Contacts

- 1 Wipe sensors and charging contacts with a clean dry cloth. You can alternately use a pad of melamine foam to remove built up debris on the robot and Home Base charging contacts.

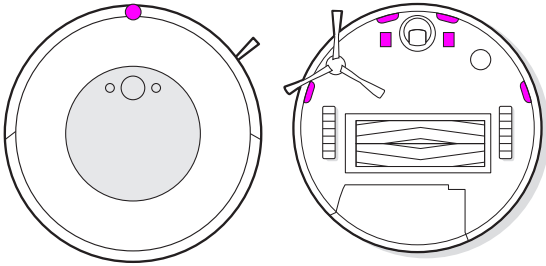

-  **Important:** Do not spray cleaning solution or water onto the sensors or sensor openings.

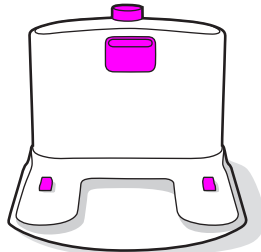

iRobot Customer Care

USA & Canada

If you have questions or comments about your Roomba® robot vacuum, please contact iRobot before contacting a retailer.

You can start by visiting global.irobot.com for support tips, frequently asked questions and information about accessories. This information can also be found in the iRobot HOME App. If you need further assistance, call our Customer Care team at **(877) 855-8593**.

iRobot USA Customer Care Hours

- Monday to Friday, 9AM – 9PM Eastern Time
- Saturday and Sunday 9AM – 6PM Eastern Time

Outside USA & Canada

Visit global.irobot.com to:

- Learn more about iRobot in your country
- Get hints and tips to improve your Roomba® robot vacuum's performance
- Get answers to questions
- Contact your local support centre

Regulatory Information



Hereby, iRobot Corporation declares that this robot vacuum cleaner model RVD-Y1 is in compliance with the EU Radio Equipment Directive 2014/53/EU. The full text of the EU Declaration of Conformity is available at the following internet address: www.irobot.com/compliance.



Hereby, iRobot Corporation declares that this robot vacuum cleaner model RVD-Y1 is in compliance with the EU Radio Equipment Directive 2014/53/EU. The full text of the UKCA Declaration of Conformity is available at the following internet address: www.irobot.com/compliance.

Chemical information report listing SVHC (substances of very high concern) per EU Regulation EU 1907/2006 can be found here: www.irobot.com/compliance.

This vacuum cleaning robot, model RVD-Y1, incorporates the Sundial radio module model: AXF-Y1. This vacuum cleaning robot, model RVD-Y1 operates in the WLAN 2.4 GHz band. The 2.4 GHz band is limited to operate between 2412 MHz and 2472 MHz with a maximum EIRP output power of 19.1 dBm (81.28 mW) at 2442 MHz.



This symbol on the product indicates that the appliance must not be disposed of with unsorted common municipal waste. As the end-user, it is your responsibility to dispose of the end-of-life appliance in an environmentally sensitive manner as follows:

- (1) returning it to the distributor/dealer from whom you purchased the product; or
- (2) depositing it in a designated collection point.

Disposing of this product correctly will help save valuable resources and prevent any potential negative effects on human health and the environment, which could otherwise arise from inappropriate waste handling. Please contact your local authority for further details or your nearest designated collection point. Penalties may be applicable for

incorrect disposal of this waste, in accordance with your national legislation. More information may be found at the following source: http://ec.europa.eu/environment/waste/weee/index_en.html

Recycle your end-of-life iRobot product responsibly per local regulations. The following is a list of the WEEE recycling organisations contracted by iRobot at the time of product sale.

Location	Organisation	URL
Austria	UFH	http://www.elektro-ade.at/elektrogeraete-sammeln/liste-der-sammelstoesterreich/
Belgium	Recupel	https://www.recupel.be/en/where-to-go/?searchcollectionPoints=&categories=1%2C2%2C3%2C4#
Germany	Zentek	https://www.ear-system.de/ear-verzeichnis/sammel-und-ruecknahmestack
Denmark	Elretul	https://www.dpa-system.dk/DPAApplications/DPADB.aspx?wf=CollectionPointSearch.as
Spain	Ecotic	https://punto-limpio.info/
France	Eco-systemes	https://www.eco-systemes.fr/france
Ireland	WEEE Ireland	http://www.weeeireland.ie/household-recycling/where-can-i-recycle/
Netherlands	Wecycle	https://www.watismijnapparaatwaard.nl/
Sweden	El-Kretsen	https://www.sopora.nu/sortera-8tervinn/
United Kingdom	Repic	http://www.responsible-recycling.co.uk/contact-us/find-your-local-recy

Manufacturer Address: iRobot Corporation, 8 Crosby Drive, Bedford MA 01730, USA

iRobot®

©2020 iRobot Corporation, 8 Crosby Drive, Bedford, MA 01730 USA. All rights reserved iRobot, Roomba, iAdapt and Virtual Wall are registered trademarks of iRobot Corporation. Home Base and Dirt Detect are trademarks of iRobot Corporation. Wi-Fi and the Wi-Fi logo are registered trademarks of Wi-Fi Alliance.

WC#: 4706317 v1