

neato

botvac **D3** connected
botvac **D5** connected



EN 01

SC 17



Meet Your Neato Robot

Congratulations on your new home robot – now “connected” in your smart home so you can manage your floor cleaning from a smartphone or tablet.

This guide will help get your robot set up and connected via the Neato app. You’ll also find some important information on operating and maintaining your robot for best performance. Then relax. Your robot will let you know when your floors are clean.

Any problems? Just let us know. We are here to help. www.neatorobotics.com/support

Important: Read Before Continuing With Setup

To ensure the best possible experience with your Neato robot, please note the following to minimize any risk of damage to household, furnishings or belongings:

Please observe your Neato robot during the first few cleaning runs and make any adjustments to the cleaning environment to optimize navigation.

- While Neato robots have a smart navigation system that avoids obstacles, the robot may occasionally bump into furniture, objects, pets and people. Therefore if you have special objects that

could potentially be damaged by the bumping, remove these objects from the room or use boundary markers.

- Similarly, the Neato robot’s rotating brush operates like a regular upright vacuum cleaner, so do not use the Neato robot on floors or rugs (e.g. with fringes) that you would not use a regular upright vacuum on.
- If the area to be cleaned contains a cliff, drop, balcony, fireplace, or other area where the vacuum could travel/fall that represents danger, place a

physical barrier to prevent travel in that area to ensure safety. The drop sensors and boundary markers are to help the robot navigate during cleaning but should not be relied upon solely to avoid a potential dangerous situation.

Neato Robotics is not responsible for any damage to furniture, objects, rugs, or flooring.

Table of Contents

Overview	3
Important Items and Tips.....	4
Preparation and Set Up.....	6
Setting Up Your Robot With Wi-Fi and the Neato App	7
Using Your Robot With the Neato App	9
How Neato Cleans	11
Maintaining Your Neato Robot	12
More Info	13
You and Your Neato Robot	16

Want to see how it's done?
Go to www.NeatoRobotics.com/support for installation videos and tips.

Overview

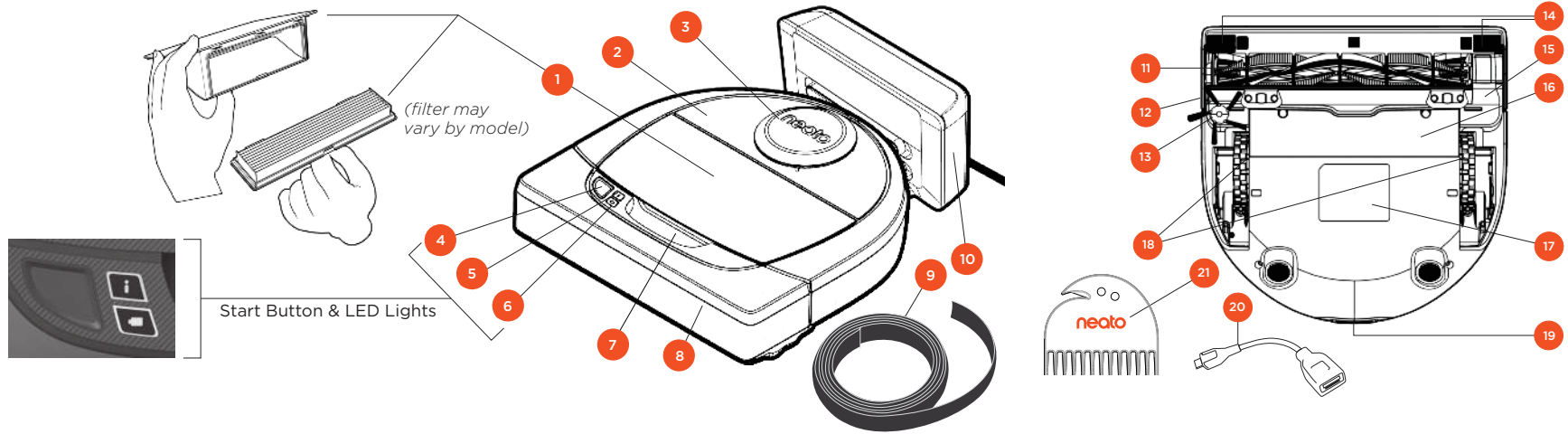

INFO LED is used for:



- Wi-Fi connection status
- Cleaning status
- Errors

BATTERY LED is used to show:



- Charge state
- Battery Errors

NOTE: LED light details are described later in this user guide.

Requirements: You need Wi-Fi, an iOS or Android phone or tablet, and a Neato account (free) in order to use some features.

1 Dirt Bin and Filter

2 Top

3 Laser Cover

4 Start Button

5 Info LED

6 Battery LED

7 Handle

8 Front Bumper

9 Boundary Marker (included in some models)

10 Charge Base

11 Brush

12 Wall Following Sensor Window

13 Side Brush (available on specific models only)

14 Drop Sensor Window

15 Brush Guard

16 Battery Door

17 Robot Label

18 Wheels

19 Charging Contacts

20 Upgrade Cable (included in some models)

21 Cleaning Tool (included in some models)

Important Items and Tips

IMPORTANT ITEMS

Keep your robot away from liquids and wet areas. Move or cover pet bowls and plant trays.

Clear the area of small items such as toys and clothing.

Tie up wires, curtains and other low-hanging items.

Thick carpet on top stair may affect the ability of the robot's navigation system to prevent falls (top stair with low pile carpet is OK). To make sure your robot sees the drop, place boundary markers 6 inches/15cm from the edge of the stair.

Keep your Neato inside the house. It was not designed for outdoor cleaning or freezing temperatures.

TIPS

To keep your robot out of places you don't want it to go, set down boundary markers (included in specific models, however Neato Boundary Markers are compatible with all Neato robots).

You can use scissors to cut boundary markers to a shorter length.

You can use removable tape to keep boundary markers flat on the floor.

To do a Reset of the Neato robot, press and hold the button for 10 seconds and all the lights will turn off. Press Start button once more to turn the robot back on.

The combo brush offers superior pick-up of pet hair, reduced noise during operation, and is ideal for homes with multiple types of flooring.

The spiral blade brush (sold separately) offers deep cleaning performance across all floor surfaces.

Shiny surfaces and black floors might cause navigation issues.

Before connecting your robot to your Neato account, view the How-To Video online at www.NeatoRobotics.com/Support

IMPORTANT: Please observe your Neato robot during the first few cleaning runs and make any adjustments to the cleaning environment to optimize navigation. Also, while Neato robots have a smart navigation system that avoids obstacles, the robot may occasionally bump into furniture, objects, pets and people. Therefore, if you have special objects that could potentially be damaged by the bumping, remove these objects from the room or use boundary markers. Similarly, the Neato robot's rotating brush operates like a regular upright vacuum cleaner, so do not use the Neato robot on floors or rugs (e.g., with fringes) that you would not use a regular upright vacuum on. Neato Robotics is not responsible for any damage to furniture, objects, rugs, or flooring.

Start Button & LED Lights

INFO LED

	ACTION	INFO LED 
Start Cleaning	Press Start Button 1x for house cleaning	Solid Blue
	Press Start Button 2x for spot cleaning	Solid White
Pause/Resume Cleaning	Press Start Button during cleaning to pause robot. Press Start Button again to resume cleaning.	LED pulses during pause
Cancel Cleaning	Press & hold Start Button for 5 seconds	Robot & LEDs turn off & robot plays a tone.

* NOTE: if the INFO LED light is blinking red or solid red, your robot needs robot maintenance or your robot has a navigation issue. Please check the troubleshooting section of this guide.

BATTERY LED

ROBOT IS:	LED COLOR	WHAT IT MEANS
Cleaning	Solid Green	Battery level is normal
	Solid Amber	Battery level is low. Battery must be charged before a new cleaning can be started
Charging	Pulsing Green	Battery is charging and robot can start cleaning
	Pulsing Amber	Robot is fast-charging the battery and must complete before cleaning can start

* If Blinking Red, please check the troubleshooting section of this guide.

Preparation and Set Up

1 REMOVE FILMS AND STICKERS

IMPORTANT

Remove all protective films and shipping material from the robot and charge base.

If they are not removed, your Neato robot will not operate correctly.

2 SET UP CHARGE BASE

Plug the power cord securely into the charge base.

Adjust the length of the cord by wrapping it as shown.

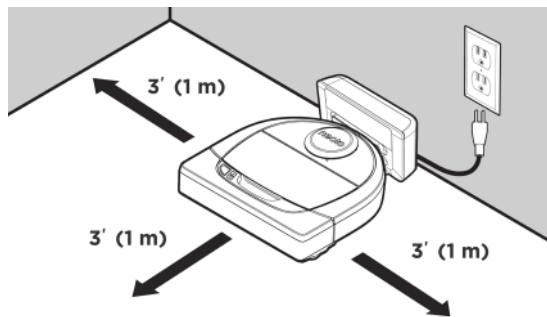
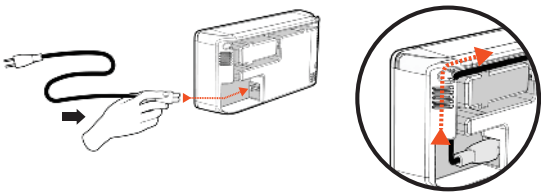

Choose a wall outlet that has a 3' (1 m) clearance on both sides and in front of the charge base. This helps your robot find the charge base.

Plug in the power cord and push the charge base against the wall.

TIP Locate the charge base on a hard floor surface.

TIP Make sure the power outlet is not controlled by a switch.

3 INITIAL ROBOT CHARGING

Place the rounded side of your Neato robot against the metal charging contacts on the charge base until the contacts are pushed all of the way in. For best results, charge the robot fully before your first cleaning cycle to experience a full high performance cleaning.

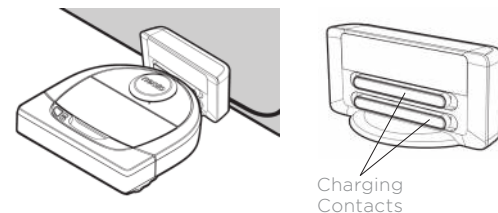

NOTE During bootup, the robot will alternately blink green and blue.

NOTE Your robot is only compatible with the included charge base.

Setting Up Your Robot With Wi-Fi Connection and the Neato App

It is **recommended** that you setup your robot to work with the Neato app to get the best experience and access to all of the features. The Neato app is the optimal way to control your robot and receive notifications via your smartphone or tablet.

Benefits of using the Neato app:

- Easy access & control
- Start your robot when you are not home
- Easily pause cleaning from the app
- Instant notifications (cleaning complete, alerts, etc.)
- Battery status
- Maintenance alerts and context sensitive help to keep your robot in top form
- Dashboard (some features available on specific models only)

It is also possible to start and stop the robot using the Start Button on the robot.

APP SET-UP

Download the Neato app from the Apple App Store or Google Play.



Follow the directions within the Neato app. You will be prompted to:

- Create an account
- Verify your account via email
- Add/Connect your robot

NOTE

Before you begin, you will need:

- Your home Wi-Fi password
- Fully charged robot

ROBOT FEEDBACK DURING INITIAL PAIRING

Follow the instructions on the Neato app to pair your robot. Your robot is in pairing mode for the first 60 minutes after you turn on your robot for the first time.

 During pairing the INFO LED will change based on the connection status:

LED COLOR	WHAT IT MEANS
Slow Blinking Blue	Robot is in Pairing Mode
Fast Blinking Blue	Pairing to Neato app/account
Solid Blue	Pairing successful (<i>shows for 5 seconds</i>)
Solid Red	Pairing unsuccessful (<i>shows for 5 seconds</i>)

PAIRING ISSUES

If you are not able to connect your robot within the first 60 minutes (or if the robot does not connect the first time), you will need to return the robot to pairing mode. Follow these steps: (Continued on next page)

Robot Wi-Fi Set-Up

PAIRING ISSUES (CONTINUED)

- Press and hold the Start button and right bumper for 10 seconds to turn robot off. The robot will turn off and revert to factory settings (and original software installed).

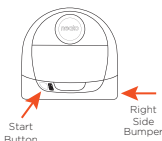

- Press the Start button once more to turn the robot on. The **i** LED will be slow blinking blue showing that the robot is now in pairing mode.
- Follow steps in the Neato app to CONNECT YOUR ROBOT.

OPERATING THE ROBOT FROM MULTIPLE SMARTPHONES & TABLETS

The Neato app can be used by multiple devices in a household to operate the same robot. Just download the Neato app to other smartphones or tablets and sign in to the same My Neato account using the email and password used to setup the robot.

NOTE

Only 2.4GHz Wi-Fi networks are supported and will display in the list of available options during robot set-up.

WEP EAP is not supported at this time.

The FCC requires all wireless devices in the US to operate on wireless spectrum channels 1-11.

If you are still having issues connecting your robot, certain Wi-Fi router firewall and port settings can prevent a connection with the Neato servers.

Please reference troubleshooting information at www.NeatoRobotics.com/support.

CONNECTING YOUR ROBOT TO ADDITIONAL NETWORKS

If you would like to add additional networks, see instructions on the Neato website support center at www.neatorobotics.com/support.

Using Your Robot With the Neato App

HOUSE CLEANING

Selecting House Cleaning sets your Neato robot to clean the entire floor on one level automatically moving from room to room.

From the app you can Start, Pause, Resume, Stop, and Return to Start/Base.

Note: When canceled mid-cleaning, your robot will stop in place. You can ask your robot to return to its base station using the Neato app. If the robot has detected the base, it will attempt to return to base and dock.

SPOT CLEANING

Selecting Clean Spot sets your Neato robot to clean a 7'x7' area and you can also select 2-pass cleaning (available only on specific models).

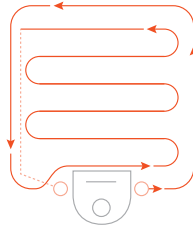

Place your robot centered and facing the area to be cleaned.

SCHEDULING YOUR NEATO ROBOT

Set up a schedule for regular vacuuming. You can set your preferences based on cleaning days and times.

NOTE If you are going away, you can turn OFF Enable Schedule to put the schedule on hold.

PUSH NOTIFICATIONS

By turning on push notifications in the app, your robot can notify you about its status. Your phone/tablet will display messages such as cleaning complete, alerts, etc.

ROBOT SOFTWARE UPDATES

Keep the software on your robot current. You can initiate a robot software update using the Neato app. Or, you can manually update the software directly on your robot.

SMART WATCH CAPABLE

If you have an Apple Watch or Android Wear smart watch, you can access some features on your watch such as start, stop, and receiving notifications. Your watch needs to be in the vicinity of your smartphone for these features to be accessible. After you have paired your smart watch with your smartphone, go to the watch app on your smartphone and turn access on to the Neato app to view features on your watch.

TROUBLESHOOTING YOUR DEVICE

When an error occurs during operation of the robot, you can click the error link in the Neato app to see what it means and what to do.

For additional information on troubleshooting your device, please see Help in the app.

Using Your Neato Robot Without the Neato App

HOUSE CLEANING

You can initiate House Cleaning by pressing the Start Button once. Your Neato robot will clean the entire floor on one level automatically moving from room to room.



Initiate House Cleaning by pressing the Start Button 1 time.

SPOT CLEANING

You can initiate Spot Cleaning by pressing the Start Button twice. During Spot Cleaning, if you press the Start Button, the robot will pause. If you press it again, it will resume. To cancel the Spot Cleaning, press the Start Button and hold it down for 5 seconds.

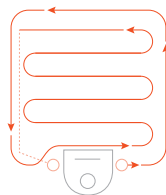

Place your robot centered and facing the area to be cleaned.

FEATURES ONLY AVAILABLE VIA THE NEATO APP

Some features are only available if you connect your robot to the Neato app on your smartphone or tablet. These features include scheduling, push notifications, context sensitive help, and cleaning statistics (specific models only).

INFO LED



	ACTION	INFO LED 
Start Cleaning	Press Start Button 1x for house cleaning	Solid Blue
	Press Start Button 2x for spot cleaning	Solid White
Pause/Resume Cleaning	Press Start Button during cleaning to pause robot. Press Start Button again to resume cleaning.	LED pulses during pause
Cancel Cleaning	Press & hold Start Button for 5 seconds	Robot & LEDs turn off & robot plays a tone.

* NOTE: if the INFO LED light is blinking red or solid red, your robot needs robot maintenance or your robot has a navigation issue. Please check the troubleshooting section of this guide.

BATTERY LED



ROBOT IS:	LED COLOR	WHAT IT MEANS
Cleaning	Solid Green	Battery level is normal
	Solid Amber	Battery level is low. Battery must be charged before a new cleaning can be started
Charging	Pulsing Green	Battery is charging and robot can start cleaning
	Pulsing Amber	Robot is fast-charging the battery and must complete before cleaning can start

* If Blinking Red, please check the troubleshooting section of this guide.

How Neato Works

HOUSE CLEANING

In normal operation, Neato comes off of its base, explores its surroundings and starts cleaning. It starts cleaning in sections approximately 15'x15' depending on layout and furniture in the room. It will continue to clean section by section until the entire area is cleaned.

Your Neato robot will also try to clean one room fully before moving on to the next, assuming it can detect your doorways. If it cleans a partial room, your Neato robot will come back to finish the room before finishing the complete job.

AUTO CHARGE AND RESUME

If the area the Neato robot is attempting to clean is very large, the robot will return to its base mid-cleaning to recharge. Once recharged, it will return to finish where it left off. A complete cleaning cycle includes 3 cleanings and 2 recharges so that Neato can clean very large areas on one level.

SINGLE ROOM CLEANING

If you just want to clean a single room, you can manually place your robot in the room, press the start button, and close the door. Your Neato robot will clean the room, and return to where you originally placed it in the room. When the robot has finished cleaning, please put the robot back on its charge base.

RETURNING TO BASE

For best results, we recommend you start your robot from its charge base. When started from its charge base, it has a better result in returning to base when it is complete.

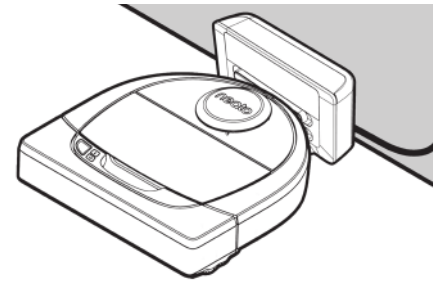

MOVING A ROBOT MID-CLEANING

It is not recommended to pick up your robot and move it mid-cleaning. It can become disoriented, not follow its normal smart behavior, and have difficulty finding its charge base. If you pick up your robot, put it back down within 1 foot of where you picked it up for best results.

Maintaining Your Neato Robot

IMPORTANT

Your robot needs regular maintenance to operate reliably. This means checking/cleaning the brushes and emptying the dirt bin after every use or as needed, depending on your environment. Failure to do this may cause problems with your robot and impact your robot's performance and void your warranty coverage.

DIRT BIN AND FILTERS

After each use, empty the dirt bin, clean the airways/openings and filter. To remove the filter, pinch the handle and pull out.

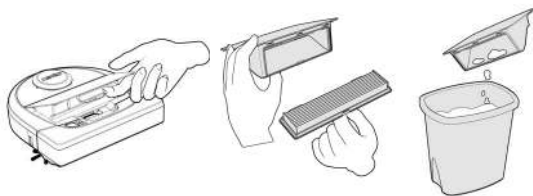

Use the cleaning tool comb to clean the filter.

Replace the filter every 1 to 2 months or more frequently as needed.

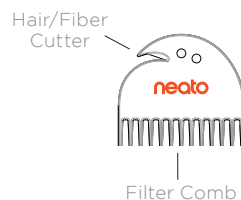

BRUSHES

If your robot has a side brush, remove the side brush and set aside. Then, remove the brush guard by pulling up on both sides.

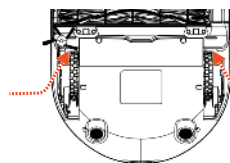

PULL UP ON BOTH SIDES SIMULTANEOUSLY

Use the hair/fiber blade to cut and remove hair from the brush. Remove any debris from the brush ends and inside the brush cavity where the brush sits. Re-insert the brush and replace the brush guard.

ROBOT TOP

Clean the top of the robot and the area around the laser top with a soft cotton cloth.

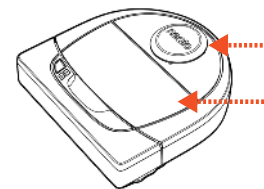

SENSORS

Use a dry cotton swab to clean the two drop sensor windows on the bottom of the robot.

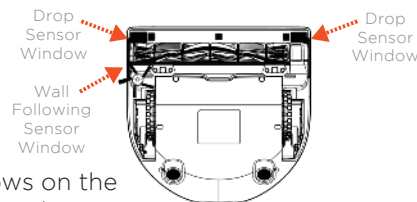

NOTE

View the Neato How-To videos online at www.NeatoRobotics.com/support to see how to maintain your robot.

More Info

ACCESSORIES

You can find information about accessories and replacement parts for your Neato robot at NeatoRobotics.com.

Always purchase Neato Genuine accessories and parts:

- Batteries
- Filters
- Brushes
- Boundary Markers
- Cleaning Tool
- Dirt Bin
- Charge Base



Using unauthorized or 3rd party accessories (non-Neato Genuine) can damage your robot and will void your warranty.

Recommended replacement schedule depends on use.

- Filters - every 1 to 2 months
- Batteries - every 12 to 18 months

REGISTER YOUR NEATO

Even if you are not using the Neato app, you can stay up to date on software releases and special offers by registering your robot. Go to NeatoRobotics.com/My-Neato to create an account and register your Neato robot.

GETTING HELP

Find more helpful information, including how-to videos, frequently asked questions, and tips & tricks for optimal operation.

Go to:

NeatoRobotics.com/Support

YouTube.com/NeatoRobotics

WARRANTY

Neato Robotics, Inc. warrants to the original purchaser that the Neato Robotics hardware product, excluding batteries, shall be free from defects in material and workmanship for 1 year from the original date of purchase.

In the case of batteries, a Warranty Period of six (6) months applies.

See complete Warranty terms at NeatoRobotics.com/Limited-Warranty. All warranties beyond those expressly stated are disclaimed to the maximum extent permissible by applicable law.

IMPORTANT INFORMATION

See separate document included with your Neato robot.

Troubleshooting



Battery LED

What it means

What to do

Blinking Red	The robot battery has experienced an error.	Please contact Customer Care. For local contact information: www.NeatoRobotics.com/Contact-Us
--------------	---	---



Info LED

What it means

What to do

Blinking Red	Your robot needs to be cleaned to operate at best performance.	<p>Follow these steps to make sure your robot is well-maintained before running it again:</p> <ol style="list-style-type: none">1 - Ensure that both the filter and dirt bin are clean and properly inserted.2 - Make sure the dirt bin is in the robot and properly seated in position. The top of the dirt bin should be level with the top of the robot if inserted correctly.3 - Make sure the brush and end caps are clear of debris and remove any hair or debris that is wrapped around it.4 - Make sure wheel wells aren't blocked with debris <p>Press the Start Button to start the robot. If it still has issues, follow the next 2 steps:</p> <ol style="list-style-type: none">5 - Using a dry cotton swab, please spin the laser housing under the laser cover 5 times in each direction being careful to avoid the openings in the housing.6 - Use a dry cotton swab to clean the two drop sensor windows on the bottom of the robot. Press the Start Button to start the robot.7 - Press and hold the Start Button for 10 seconds to reset your robot. All of the lights on the robot will turn off. Press the Start Button to turn the robot back on. <p>Go to the support center to watch how-to videos on these maintenance items.</p>
--------------	--	--

Troubleshooting *(continued)*

 Info LED	What it means	What to do
Solid Red	<p>The Neato robot is having difficulty navigating the environment. Possible reasons for this:</p> <ul style="list-style-type: none"> • The laser is blocked. • It is having difficulty navigating the floor. • The sensors are dirty or not working properly. • The wheels or brush are dirty. 	<p>Follow these steps to troubleshoot. Make sure:</p> <ol style="list-style-type: none"> 1 - Nothing in the environment has changed since the robot started cleaning (e.g., furniture moved, robot moved to different room) 2 - Wheel wells aren't blocked with debris. 3 - The battery is charged. 4 - If the robot still has issues, reset the robot by pressing and holding the button for 10 seconds. The robot will turn off. Press the Start Button to turn it back on. Try running the robot again. <p>Press the button to start the robot. If it still has issues,</p> <ol style="list-style-type: none"> 5 - Make sure the robot's laser freely rotates: Use a dry cotton swab to rotate the laser 5 times to the left and 5 times to the right, making sure NOT to put the cotton swab in either hole. 6 - Using compressed air, use short bursts of compressed air about 6" away. <p>Let the robot fully charge. Try running the robot again. If issue persists, click on Chat icon for assistance at www.NeatoRobotics.com/support, or visit our Customer Care contact page for more options.</p>
Neato app robot status	<p>What it means</p> <p>"Robot Offline" message in the Neato app</p> <p>The robot has disconnected from its Wi-Fi connection – OR – your phone/tablet is not connected to a 3G or 4G service.</p>	<p>What to do</p> <p>Check or try the following items in the order provided.</p> <ol style="list-style-type: none"> 1 - Make sure your phone/tablet is connected to 3G or 4G service. If your phone is not connected, your Neato app will say your robot is OFFLINE. 2 - Reset your Neato robot by taking it off of its base, press and hold the start button for 10 seconds to turn it off, and then press Start button one more time to turn it on. Wait a few minutes and then check the Neato app to see if it now says READY TO CLEAN. 3 - If #1 or #2 do not fix the issue: Delete your robot from the Neato app and go through the steps to Connect your Robot again. It should then say READY TO CLEAN.

If issue persists, please contact Neato Customer Care www.NeatoRobotics.com/support

NOTE Context Sensitive help is also provided in the Neato app to help you troubleshoot items. Go to www.NeatoRobotics.com/support for more troubleshooting tips.

You and Your Neato Robot

Congratulations on your new Neato robot. You will soon experience the joy of having clean floors without ever pushing a vacuum.

Observe your robot during the first few cleaning runs. You may find that a few small adjustments in your home (moving a chair or lamp a few inches, picking up cords) will make a big difference in your experience/results.

Help your robot and your robot will help you. 😊

认识一下您的 Neato 机器人

恭喜您拥有了一台新的家用机器人 — 马上“连接”到智能家庭，使用智能手机或平板电脑控制机器人进行地板清扫。

本指南将指导您设置和通过 Neato 应用程序连接机器人。此外，指南中还提供了一些有关运行和维护机器人的重要信息，以帮助您获得最佳性能。清扫过程十分轻松。并且机器人会在地板清扫完成后向您发出通知。

重要信息：设置前必读

为确保 Neato 机器人为您带来最佳体验，请认真阅读以下注意事项，以最大程度降低对您的家居用品或财产造成损害的风险。

在使用 Neato 机器人进行前几次清洁时，请注意观察并根据清洁环境作出相应调整，以确保获得最佳的导航效果。

• 尽管 Neato 机器人带有可规避障碍物的智能导航系统，但偶尔还是会撞到家具、物体、宠物和人。因此，如果您

的某些特殊物品可能会因这种碰撞受到损害，请将这些物品从房间移出或者使用边界标记。

• Neato 机器人旋转刷的运行方式与立式吸尘器相似，所以请勿在不可使用常规立式吸尘器的地面或地毯（如带有流苏）上使用 Neato 机器人。

• 如果待清扫的区域内有壁面、跌落点、阳台、壁炉，或者是其他机器人吸尘器可能会行进或跌落的可能存在危

险的区域，可设置物理屏障以防机器人吸尘器行进到该区域，以确保使用安全。跌落传感器和边界标记可帮助机器人吸尘器在清扫过程中进行导航，但不应仅仅以此来避免发生危险情况。

Neato Robotics 对家具、物品、地毯或地板受到的任何损害不承担任何责任。

目录

概览.....	3
重要内容和提示.....	4
准备和设置.....	6
通过 Wi-Fi 和 Neato 应用程序设置机器人.....	7
使用 Neato 应用程序控制机器人.....	9
Neato 的清洁方式.....	11
维护您的 Neato 机器人.....	12
更多信息.....	13
您与您的 Neato 机器人.....	16

想要观看示范？

请到 www.NeatoRobotics.com/support 获取安装视频与使用技巧。

概览

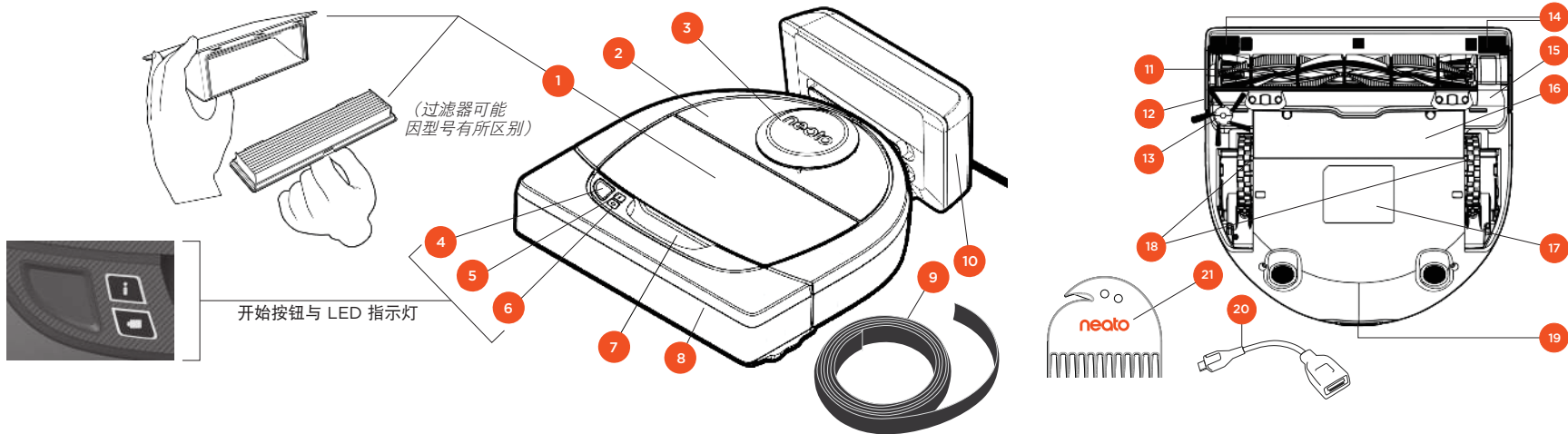

信息 LED 指示灯用于指示：



- Wi-Fi 连接状态
- 清洁状态
- 错误

电池 LED 指示灯用于指示：



- 充电状态
- 电池错误

注意：LED 指示灯将在本用户手册的后面详细介绍。

使用要求：使用某些功能需要拥有 Wi-Fi、一部 iOS 或 Android 手机或平板电脑以及一个 Neato 帐户（免费）。

1 尘盒和过滤器

- 2 顶盖
- 3 激光罩
- 4 开始按钮
- 5 信息 LED 指示灯
- 6 电池 LED 指示灯
- 7 手柄
- 8 前缓冲器
- 9 边界标记（限某些型号）
- 10 充电座

11 滚刷

- 12 沿墙行走传感器窗口
- 13 边刷（仅限特定型号）
- 14 防跌落传感器窗口
- 15 滚刷盖板
- 16 电池门
- 17 机器人标签
- 18 滚轮
- 19 充电触点
- 20 升级线（限某些型号）
- 21 清洁工具（限某些型号）

重要内容和提示

重要内容

确保您的机器人远离液体和潮湿区域。移走或盖上宠物餐具和植物托盘。

清理放有玩具和衣物等小物件的区域。

捆扎丝线、窗帘和其他低垂物件。

楼梯顶部的厚地毯可能会影响机器人导航系统的防跌落性能（薄地毯没有问题）。为确保机器人能看到楼梯，请在距离楼梯边缘 6 英寸/15 厘米处放置边界标记。

Neato 仅适用于室内清扫。不可将其用于室外清扫，或在零度以下的环境中使用。

提示

要使机器人远离您不想打扫的区域，可借助边界标记（仅特定型号提供，但兼容所有 Neato 机器人）。

可以使用剪刀将边界标记剪短。

可以使用可移除胶带将边界标记平整地贴在地板上。

如要重设 Neato 机器人，请按住按钮 10 秒，此时所有指示灯都将熄灭。再次按下开始按钮，机器人重新启动。

组合滚刷可十分有效地清扫宠物毛发，并且运行噪音更低，非常适合地板类型多样的家庭。

螺旋叶片滚刷（单独另售）在所有地板上均可完成深度彻底清扫。

光亮表面和黑色地板可能导致导航问题。

在将机器人与 Neato 账户连接之前，请先到 www.NeatoRobotics.com/Support 观看操作说明视频

重要信息：在使用 Neato 机器人进行前几次清洁时，请注意观察并根据清洁环境作出相应调整，以确保获得最佳的导航效果。尽管 Neato 机器人带有可规避障碍物的智能导航系统，但机器人偶尔还是会撞到家具、物体、宠物和人。因此，如果您的某些特殊物品可能会因这种碰撞受到损害，请将这些物品从房间移出或者使用边界标记。Neato 机器人旋转刷的运行方式与立式吸尘器相似，所以请勿在不可使用常规立式吸尘器的地面或地毯（如带有流苏）上使用 Neato 机器人。Neato Robotics 对家具、物品、地毯或地板受到的任何损害不承担任何责任。

开始按钮与 LED 指示灯

信息 LED 指示灯

	操作	信息 LED 指示灯 
开始清扫	按“开始”按钮 1 次清扫房间 按“开始”按钮 2 次定点清扫	蓝色常亮 白色常亮
暂停/继续清扫	清扫过程中按下“开始”按钮可暂停机器人。 再次按下“开始”按钮可继续清扫。	暂停时 LED 指示灯闪烁
取消清扫	按住“开始”按钮 5 秒钟	机器人关闭，LED 指示灯熄灭，机器人发出提示音。

* 注意：如果信息 LED 指示灯闪烁红灯或红色常亮，则表示机器人需要维护，或机器人导航出现问题。请参阅本手册中的故障排除部分查找解决方法。

电池 LED 指示灯

机器人状态	LED 颜色	含义
清扫中	绿色常亮	电池电量正常
	琥珀色常亮	电池电量低。电池需进行充电方能继续进行清扫
充电中	绿色闪烁	电池正在充电，机器人可以开始清扫
	琥珀色闪烁	机器人电池正在快速充电，待其完成后方能开始清扫

* 如闪烁红灯，请参阅本手册中的故障排除部分查找解决方法。

准备和设置

1 除去薄膜和贴纸

重要信息

除去机器人和充电座上的所有保护膜和运输材料。
如不除去这些东西，Neato 机器人将无法正常运行。

2 设置充电座

将电源线牢牢插入充电座。
按图中所示调整电源线长度。

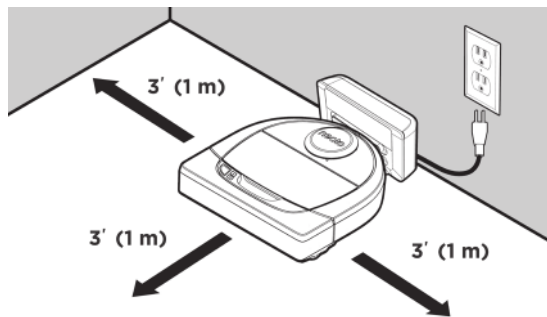
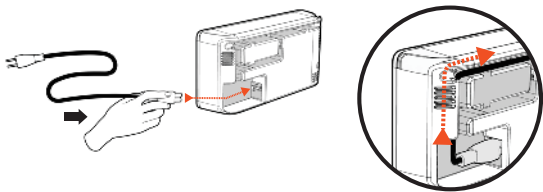

选择一个充电座两侧及前方空隙能够达到 3 英尺 (1 米) 的壁式插座。这有助于机器人找到充电座。

插入电源线，推动充电座使其靠在墙壁上。

提示 请将充电座置于硬地板表面。

提示 请确保电源插座不是由开关控制。

3 机器人初次充电

将 Neato 机器人的圆端对准充电座的金属充电接触点并顺利插入。为求最佳效果，请在执行首次清扫循环之前将机器人充满电，体验一次完整的高性能清扫。

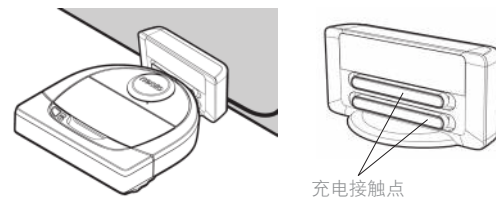

注意 机器人启动期间绿色与蓝色交替闪烁。

注意 您的机器人仅兼容随附的充电座。

通过 Wi-Fi 连接和 Neato 应用程序设置机器人

建议通过 Neato 应用程序对机器人进行设置，以获得最优体验并使用完整功能。最好是使用 Neato 应用程序，通过智能手机或平板电脑控制机器人并接收通知。

使用 Neato 应用程序控制机器人具有以下优势：

- 方便访问和控制
- 不在家时亦可启动机器人
- 通过应用程序即可轻松暂停清扫
- 即时通知（清扫完成、警报等）
- 电池状态
- 维护警报和上下文相关帮助有助于始终保持机器人的最佳状态
- 控制面板（某些功能仅限特定型号）

也可以通过机器人身上的开始按钮启动和停止机器人。

应用程序设置

从 Apple App Store 或 Google Play 下载 Neato 应用程序。



请按照 Neato 应用程序中的指示进行操作。将显示以下提示：

- 创建账户
- 通过电子邮件验证您的账户
- 添加/连接您的机器人

注意

开始之前，您需要：

- 知道家中的 Wi-Fi 密码
- 将机器人充满电

初次配对期间的机器人反馈

请按照 Neato 应用程序上的说明完成机器人配对。首次打开机器人后 60 分钟内，机器人均处于配对模式。

 配对期间，信息 LED 指示灯将根据连接状态有所变化：

LED 颜色	含义
蓝色慢闪	机器人正处于配对模式
蓝色快闪	与 Neato 应用程序/账户配对中
蓝色常亮	配对成功（显示 5 秒）
红色常亮	配对失败（显示 5 秒）

配对问题

如果未能在开始的 60 分钟内完成机器人连接（或机器人第一次无法连接），则需将机器人返回配对模式。请按以下步骤进行操作：
（接下页）

机器人 Wi-Fi 设置

配对问题 (续)

- 按住“开始”按钮和右缓冲器 10 秒关闭机器人。机器人将关闭并恢复出厂设置（并安装初版软件）。



- 再次按下开始按钮，启动机器人。LED 指示灯将慢闪蓝灯，表示机器人正处于配对模式。
- 请按照 Neato 应用程序上的说明连接机器人。

通过多部智能手机与平板电脑操作机器人

家中的多部设备均可使用 Neato 应用程序来操作同一个机器人。只需将 Neato 应用程序下载到其他智能手机或平板电脑，然后使用设置机器人所用的电子邮件和密码登录相同的 My Neato（我的 Neato）账户。

注意

机器人设置过程中，仅支持 2.4GHz Wi-Fi 网络，该网络也将是可用选项列表中显示的唯一选项。

此时不支持 WEP EAP。

FCC 要求美国的所有无线设备均在无线频谱通道 1-11 中运行。

如果仍不能连接机器人，则可能是某个 Wi-Fi 路由器防火墙和端口设置阻止了与 Neato 服务器的连接。

请参阅 www.NeatoRobotics.com/support 获取故障排除信息。

将机器人连接至其他网络

如想添加其他网络，请访问 www.neatorobotics.com/support 参阅 Neato 网站支持中心相关说明。

使用 Neato 应用程序控制机器人

多房间清扫

选择“多房间清扫”，可让 Neato 机器人一个接一个房间地自动完成某一层全部地板的清扫。

您可以通过应用程序启动、暂停、继续、停止和返回起点/充电座。

注意：如在清扫中途取消，机器人会就地停止。您可以使用 Neato 应用程序命令机器人返回充电座位置。如果机器人检测到了充电座，即会尝试返回充电座并完成对接。

定点清扫

选择“定点清扫”，即可让 Neato 机器人清扫一块 2 米 x 2 米面积的区域，且可选择两遍清扫（仅限特定型号）。

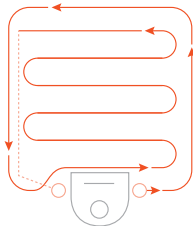

将机器人置于中央，使其朝向要清扫的区域。

定时预约您的 NEATO 机器人

设置日常吸尘工作的定时预约。您可以设置清扫日期和时间偏好。

注：如要离开，可以关闭“启用定时预约”暂停定时预约。

推送通知

打开应用程序中的推送通知，机器人即可告知您当前状态。您的手机/平板电脑会显示清扫完成、警报等信息。

机器人软件更新

确保您的机器人配备最新软件。可通过 Neato 应用程序启动机器人软件更新。也可直接在机器人上手动更新软件。

支持智能手表

佩戴 Apple Watch 或 Android Wear 智能手表时，可通过手表使用启动、停止和接收通知等功能。手表要靠近智能手机才能使用上述功能。首选将智能手表与智能手机配对，然后进入智能手机上的手表应用程序，开启对 Neato 应用程序的访问，之后即可通手表查看各种功能。

设备故障排除

机器人运行期间如发生错误，可点击 Neato 应用程序中的错误链接，查看具体含义和相应措施。

有关设备故障排除的更多详情，请参阅应用程序中的帮助。

在不借助 Neato 应用程序的情况下使用机器人

多房间清扫

按开始按钮一次可启动多房间清扫 Neato 机器人将一个接一个房间地自动完成某一层全部地板的清扫。



按开始按钮一次启动多房间清扫。

定点清扫

按开始按钮两次启动定点清扫。定点清扫期间，如果按下开始按钮，机器人就会暂停。再按则又继续。如要取消定点清扫，请按住开始按钮 5 秒钟。

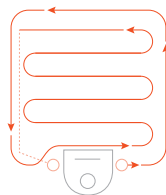

将机器人置于中央，使其朝向要清扫的区域。

只能通过 NEATO 应用程序实现的功能

有些功能要求必须将机器人连接到智能手机或平板电脑上的 Neato 应用程序。其中包括定时预约、推送通知、上下文相关帮助以及清扫统计（仅限特定型号）。

信息 LED 指示灯

操作	信息 LED 指示灯 
开始清扫	按“开始”按钮 1 次清扫房间 按“开始”按钮 2 次定点清扫
暂停/继续清扫	清扫过程中按下“开始”按钮可暂停机器人。 再次按下“开始”按钮可继续清扫。
取消清扫	按住“开始”按钮 5 秒钟

* 注意：如果信息 LED 指示灯闪烁红灯或红色常亮，则表示机器人需要维护，或机器人导航出现问题。请参阅本手册中的故障排除部分查找解决方法。

电池 LED 指示灯

机器人状态	LED 颜色	含义
清扫中	绿色常亮	电池电量正常
	琥珀色常亮	电池电量低。电池需进行充电方能继续进行清扫
充电中	绿色闪烁	电池正在充电，机器人可以开始清扫
	琥珀色闪烁	机器人电池正在快速充电，待其完成后方能开始清扫

* 如闪烁红灯，请参阅本手册中的故障排除部分查找解决方法。

Neato 的工作原理

多房间清扫

正常情况下，Neato 会离开充电座，探索周边环境并开始清扫。它会根据房间的布局和家具进行分块清扫，每块的面积约为 4.6 米 x 4.6 米。清扫工作逐块连续进行，直到完成整个区域的清扫。

Neato 机器人还会尽量在清扫完一个房间之后，再去清扫下一个房间，前提是要能够检测到房门。请注意：如果只清扫了房间的一部分，Neato 还会返回继续清扫房间剩余部分，直到完成全部任务。

自动充电和继续工作

如果 Neato 机器人待清扫面积太大，机器人会在中途返回充电座充电。充电完成后，会返回离开处继续工作。一次完整的清扫循环包含 3 次清扫和 2 次充电，因此 Neato 能够完成对某层地面大面积的清扫任务。

单房间清扫

如果只想清扫一个房间，可以手动将机器人置于房间内，按下开始按钮后关上房门。Neato 机器人会清扫房间，完成后返回最初放置的位置。待机器人完成清扫后，请将其放回充电座。

返回充电座

为达到最佳效果，建议您于充电座处启动机器人。如从充电座处启动，机器人可在完成任务后更顺利地返回充电座。

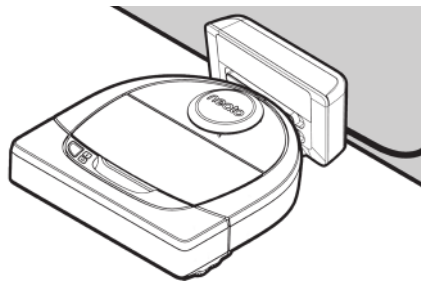

清扫过程中移动机器人

不建议在机器人清扫过程中将其拿起。机器人会失去方向，行动异常，并且难以找到充电座。如已拿起机器人，请将其放回距拿起位置 30 厘米以内的地方，以求最佳效果。

维护您的 Neato 机器人

重要信息

为确保机器人稳定运行，需定期对其进行维护。这表示需要在每次使用后或根据需要检查/清洁滚刷并清空尘盒（具体视环境而定）。否则可能导致机器人出现问题，影响机器人的性能并导致保修失效。

尘盒和过滤器

每次使用后，请清空尘盒，并清洁通风道/开口和过滤器。捏住手柄将其拉出，取出过滤器。

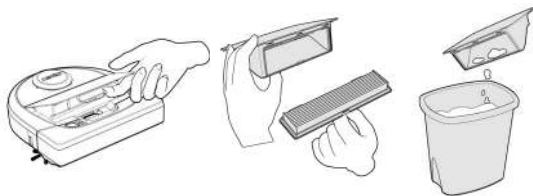

使用清洁工具梳清洁过滤器。

应根据需要每 1 到 2 个月或更短时间更换过滤器。

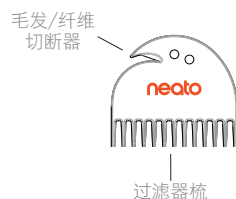

滚刷

如果机器人有边刷，请将其拆下后放到旁边。然后，向上提拉两侧，拆下滚刷盖板。

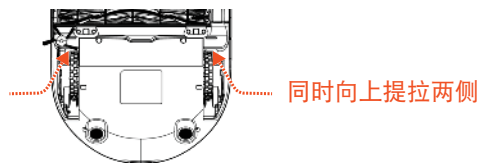

使用毛发/纤维刀片切割并除去滚刷上的毛发。清除滚刷末端及滚刷所在滚刷槽内的所有杂物。重新插入滚刷，并更换滚刷盖板。

机器人顶部

请用软棉布清洁机器人顶部和激光器顶盖周边区域。

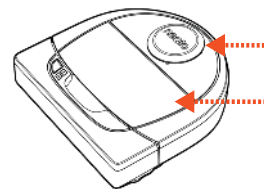

传感器

使用干棉签清洁机器人底部的两个防跌落传感器窗口。

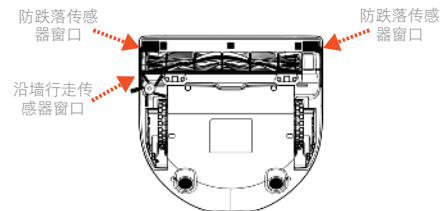

注意

请访问 www.NeatoRobotics.com/support 在线观看 Neato 操作说明视频，了解如何维护机器人。

更多信息

配件

您可以在 NeatoRobotics.com 查找 Neato 机器人配件和替换件的相关信息。

请务必购买 Neato 原装配件和部件：

- 电池过滤器
- 过滤器
- 滚刷
- 边界标记
- 清洁工具
- 尘盒
- 充电座



使用未经授权或第三方配件（非 Neato 原装）可能损坏您的机器人并使保修失效。

建议更换周期（实际更换周期视使用情况而定）。

- 过滤器 - 每 1 到 2 个月
- 电池 - 每 12 到 18 个月

注册您的 NEATO

即使不使用 Neato 应用程序，也可通过注册机器人及时获取最新的软件版本和特价优惠。请访问 NeatoRobotics.com/My-Neato 创建账户，注册您的 Neato 机器人。

获取帮助

如要了解更多信息（包括操作说明视频、常见问题和使机器人保持最佳运行状态的诀窍），

请访问：

NeatoRobotics.com/Support

YouTube.com/NeatoRobotics

保修

Neato Robotics, Inc. 向原始购买者保证，Neato Robotics 硬件产品（电池除外）自初始购买之日起 1 年内不会出现任何材料和工艺缺陷。

电池保修期为六 (6) 个月。

请访问 NeatoRobotics.com/Limited-Warranty 了解详细的保修信息。除明确声明的保修外，所有其他保修在适用法律允许的最大范围内均不予承认。

重要信息

请参阅 Neato 机器人随附的独立文档。

故障排除

 电池 LED 指示灯	含义	相应措施
红色闪烁	机器人电池故障。	请联系客服。本地联系人信息请查看： www.NeatoRobotics.com/Contact-Us

 信息 LED 指示灯	含义	相应措施
红色闪烁	机器人需要清洁才能保持最佳运行状态。	<p>再次运行之前，请按下述步骤确保机器人得到良好的维护：</p> <ol style="list-style-type: none">1 - 确保过滤器和尘盒均已清理干净且正确插入。2 - 确保尘盒在机器人中，并且已正确安装到位。尘盒若已正确插入，其顶部应与机器人顶部平齐。3 - 确保滚刷和端盖无任何杂物，并去除包覆的所有毛发或杂物。4 - 确保轮舱未被杂物堵塞。 <p>按下开始按钮启动机器人。如果问题仍然存在，请执行以下两个步骤：</p> <ol style="list-style-type: none">5 - 请使用干棉签将激光罩下方的激光器外壳在每个方向上旋转 5 次，且要小心避开外壳的开口。6 - 使用干棉签清洁机器人底部的两个防跌落传感器窗口。按下开始按钮启动机器人。7 - 按住开始按钮 10 秒钟以重置机器人。机器人所有指示灯将熄灭。按下开始按钮，再次启动机器人。 <p>维护操作的相关操作说明视频，请到支持中心观看。</p>

故障排除 (续)

 信息 LED 指示灯	含义	相应措施
红色常亮	Neato 环境导航受阻。造成此种情况的原因包括： <ul style="list-style-type: none"> • 激光被挡住。 • Neato 地板导航受阻。 • 传感器很脏或者无法正常工作。 • 滚轮或滚刷脏了。 	按照以下步骤进行故障排除。请确保： <ol style="list-style-type: none"> 1 - 自机器人开始清扫后，环境中没有任何改变（例如，家具搬动、机器人被移至另一个房间） 2 - 轮舱未被碎屑堵塞。 3 - 电池已充电。 4 - 如果机器人问题仍然存在，请按住按钮 10 秒钟，重启机器人。机器人将关闭。按下开始按钮，机器人重新启动。尝试再次运行机器人。 按下按钮启动机器人。如果问题仍然存在， <ol style="list-style-type: none"> 5 - 确保机器人的激光器可自由旋转：使用干棉签将激光器向左旋转 5 次，再向右旋转 5 次，但注意不要将棉签插入任何一个孔中。 6 - 使用压缩空气，距离大约 6 英寸远喷射短促急流压缩空气。 将机器人充满电。尝试再次运行机器人。如果问题仍然存在，请访问 www.NeatoRobotics.com/support 并点击聊天图标寻求帮助，或是访问我们的客服联系人页面寻找更多协助方式。

Neato 应用显示的机器人状态	含义	相应措施
Neato 应用中显示“机器人离线”	机器人已和 Wi-Fi 断开连接或您的手机/平板电脑未连接到 3G 或 4G 服务。	请按下方所示步骤进行检查。 <ol style="list-style-type: none"> 1 - 确保您的手机/平板电脑已连接到 3G 或 4G 服务。如果手机未连接，Neato 应用会提示机器人处于“离线”状态。 2 - 重置 Neato 机器人：将机器人从充电座上取下，按住开始按钮 10 秒钟将其关机，然后再按一次开始按钮将其打开。等待几分钟，然后检查 Neato 应用是否显示“准备清扫”。 3 - 如果第 1 步和第 2 步均未解决问题：请将机器人从 Neato 应用中删除，然后重新连接机器人。重新连接后，Neato 应用就会显示“准备清扫”。

如果问题持续存在，请联系 Neato 客户关怀部门 www.NeatoRobotics.com/support

注意：Neato 应用程序同时提供上下文相关帮助，有助于您排除故障。请访问 www.NeatoRobotics.com/support 获取更多故障排除提示。

您与您的 Neato 机器人

恭喜您拥有了一台全新的 Neato 机器人。您再也无需拖动沉重的吸尘器来清扫地板，将很快享受到轻松惬意的清扫体验。

请在机器人前几次进行清扫时观察机器人。您会发现，只需要稍微调整一下家中的物品（将椅子或灯移动几英寸，将线绳收捡起来），就将获得完全不同的清扫体验/效果。

您与您的机器人应当互相帮助。😊



botvac **D3** connected



botvac **D5** connected



Neato Robotics, Inc.
8100 Jarvis Avenue
Newark, CA 94560 USA
NeatoRobotics.com

P/N 515-0048 Rev. 2