

Roborock Xiaowa Robotic Vacuum Cleaner Manual

Please read this manual carefully before using the product and store it properly

xiaowa

Safety Information

Restrictions

- This product is designed for indoor floor cleaning only, do not use it outdoors (such as on an open-ended terrace), on any surface other than the ground (such as a sofa), or in any commercial or industrial environment
- Do not use this product on elevated surfaces without barriers such as the floor of a loft, an open-ended terrace, or on top of furniture
- Do not use the product when the ambient temperature is higher than 40°C, lower than 4°C, or if there are liquids or tacky substances on the floor
- Before using the product, move wires off the ground or place them to the side to prevent them being pulled on by the cleaner
- To prevent blocking the product and to avoid damage to valuables, remove lightweight items (such as plastic bags) and fragile objects (such as vases) from the floor before cleaning
- Children should be supervised to ensure that they do not interfere with the product
- This product is not intended for use by persons (including children) with reduced physical, sensory or mental capabilities, or a lack of experience and knowledge, unless they have been given supervisor instruction concerning use of the product by a person responsible for their safety (CB)

Safety Information

This product can be used by children aged age 8 years and above and persons with reduced physical, sensory or mental capabilities or a lack of experience and knowledge once they have been given supervision or instruction concerning the safe use of the product and understand the hazards involved. Children should not play with the appliance. Cleaning and maintenance should not be carried out by children without supervision (EU)

- Keep the main brush cleaning tools out of reach of children
- Do not place any object (including children and pets) on the product, whether it is in operation or not
- Keep hair, loose clothing, fingers, and all parts of the body away from openings and moving parts
- Do not use the product on burning objects (such as cigarette butts)
- Do not use the product on high pile carpets (product effectiveness may also be reduced on dark carpets)
- Do not use the product to clean hard or sharp objects (such as glass and nails)
- Do not carry the product using the laser scanner cap, main unit cover, or collision buffer

Safety Information

- The product must be switched off and the plug must be removed from socket-outlet before cleaning or maintaining the appliance
- Do not use wet cloth or liquids for cleaning the product
- Do not use the mopping module on carpets
- Use the product according to the manual. Any loss or damage caused from improper use will be borne by the user

Battery and Charging

WARNING

- For the purposes of recharging the battery, only use the detachable supply Unit Xiaowa CDZ03RR or CDZ04RR provided with this product
- Do not dismantle, repair or modify the battery or charging dock
- Keep the charging dock away from heat (such as heating vents)
- The battery must be removed from the product before it is disposed of
- The product must be disconnected from the mains supply when removing the battery
- The battery must be disposed of safely. Do not discard waste batteries. Leave them with a professional recycling organization
- Do not wipe or clean the charger prongs with wet cloth or wet hands

Safety Information

If the supply cord is damaged, it must be replaced by the manufacturer, its service agent or similarly qualified persons in order to avoid a hazard

- Make sure the product is powered off before shipment. Use of the original packaging is advised
- If to be left unused for a long period of time, fully charge the product and switch it off before storing it in a cool, dry place. Charge it at least every three months to avoid over discharging the battery

Table of Faults of Robotic Vacuum Cleaner

Table of Faults of Robotic Vacuum Cleaner	
Item	Faults
Main unit	Functions do not work
	Does not power on
	Main brush, side brush, fan or main wheel issue
Charging dock	Main unit does not charge
Power cable	Charging dock has no power

blank, for marketing purpose), which build-in Rechargeable Li-on battery pack.
 Charging dock: Xiaowa CD203RR/ CD204RR suitable for Xiaowa Robotic Vacuum Cleaner: C1****(-carbe0to9AtoZatoz..."/, or

Rechargeable Li-on battery pack information	
Model	
Rated capacity	BRR-1P4S-2600S/BRR-1P4S-2600D
Rated voltage	2600mAh/37.44Wh
Limited charge voltage	16.8VDC

Cell number 4

Introduction

Main unit

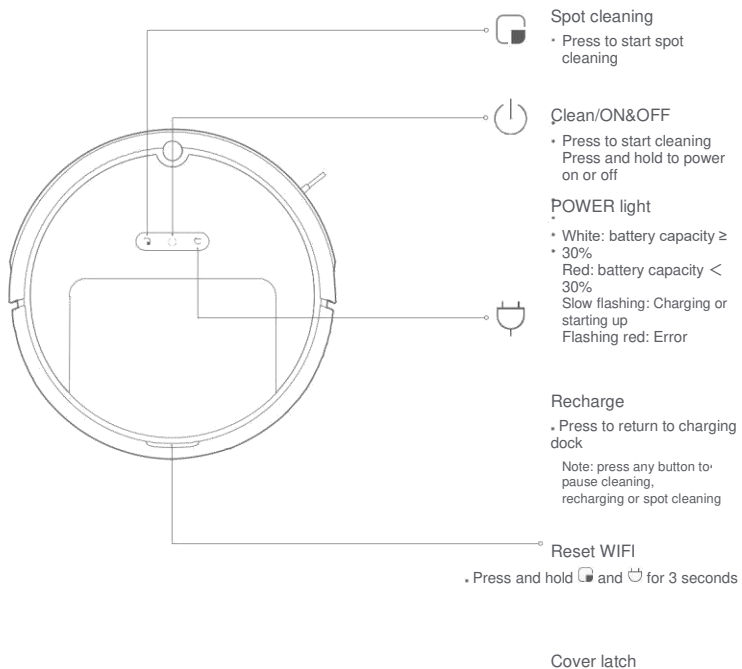

Introduction

Dust bin

Main unit

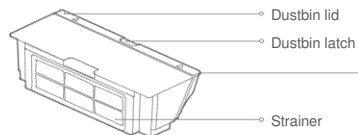

Dustbin lid

Dustbin latch

Strainer

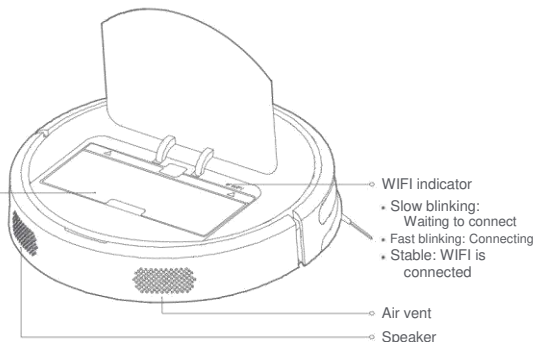

WiFi indicator

- Slow blinking: Waiting to connect
- Fast blinking: Connecting
- Stable: WiFi is connected

Air vent

Speaker

Accessories

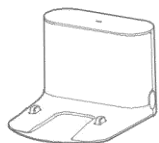

Charging dock



Main brush cleaning tool

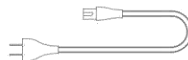

Power cable

Introduction

Main unit and sensors

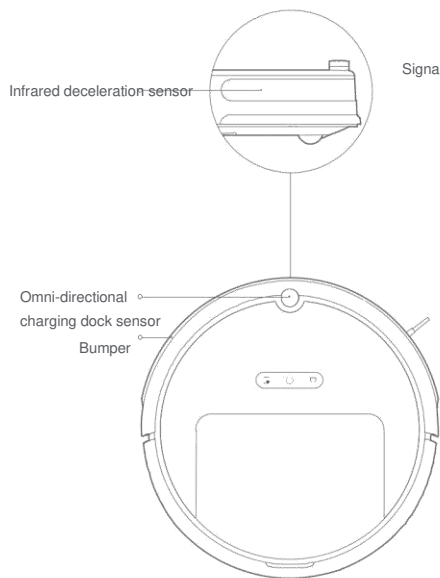

Charging dock

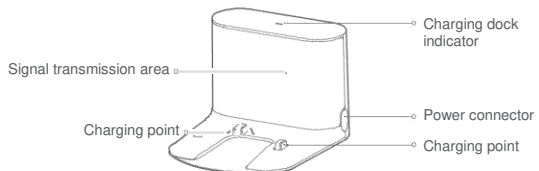

Cliff Sensor

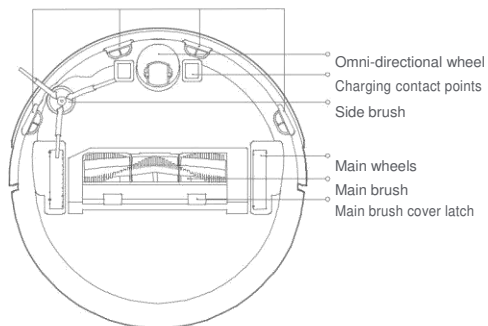

Installation

- 1 Connect the power cable and use a cable tie to clear excess wiring

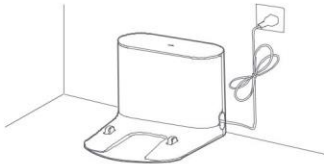

- 2 Place the charging dock on a level surface, flat against a wall, plugged into a power outlet.

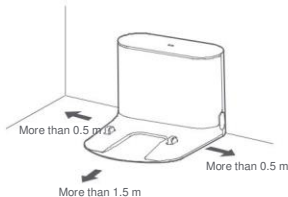

Notes:

- Leave at least 20in (50cm) either sides, and at least 60in (150cm) in front of the charging dock
 - Poor placement may cause the charging dock to be dragged by the product, causing power dropout.
 - The charging dock indicator light switches on when plugged into a power outlet, and is off when the main unit is being charged.
- Placement in an open area will improve cleaning efficiency

- 3 Powering on and charging

Press and hold the  button to power on, wait until the power light stops flashing, then dock the main unit to the charging dock to charge

The product is equipped with a high-performance lithium-ion rechargeable battery. Keep the product charged for maximum battery performance.

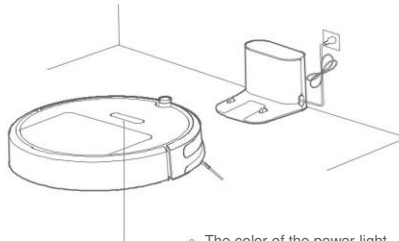

- The color of the power light indicates battery level
- White: battery capacity \geq 30%
 - Red: battery capacity $<$ 30%

Note: The product may not switch on when power is low. Connect it to a charging dock before switching on.

- 4 Connect to smartphone (optional)

Installation

The product is compatible with the Mi Home smarthome platform and can be controlled in the Mi Home app. It supports the MIUI system and can be linked with other Mi Home intelligent products.

Quick Setup

1 Download App



Search "Mi Home" in App store/Google play or scan the QR code below to download and install the Mi Home app.



2 Add Device

Go to the "My Device" page of the Mi Home app and tap "+" on the top right corner. Find newly added devices in the "My Device" list

3 Reset WIFI

To Reset the WIFI to default, open the upper cover to check the WIFI indicator status next to the reset button. Press and hold the  key and  key until you hear "Reset WIFI ". Resetting is completed when the WIFI indicator flashes slowly. The product will enter a pending connection state.

Installation

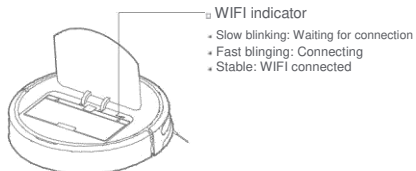

Note: If you cannot connect to the product, refer to Reset WiFi in the User Manual

5 Start cleaning

When the power light changes from blinking white to stable, charging is complete. Press the (1) button or use the Mi Home app to start cleaning

Routine Maintenance

Main brush *Clean weekly

1. Turn over the main unit and press the latch to remove the main brush cover
2. Lift out the main brush and clean its bearings
3. Use supplied main brush cleaning tool to cut any entangled hair
4. Reinstall the main brush and close the cover tightly

Note: Replacing the main brush every 6-12 months is recommended for maximum cleaning efficiency

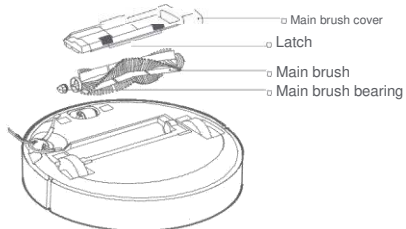

Using the main brush cleaning tool

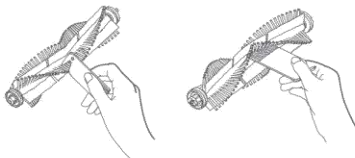

Routine Maintenance

Dust bin and filter * Clean weekly

1. Open the top cover of the product and press the dust bin latch then lift and remove the dust bin

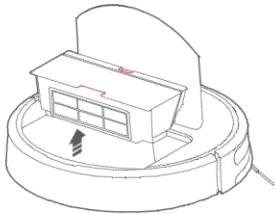

2. Open the dust bin cover as indicated

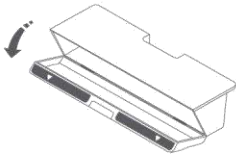

3. Turn the dust bin over and pour out the dust

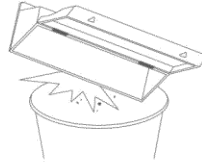

Note: To avoid filter blockage, tap the dustbin lightly on the edge of the bin

Routine Maintenance

Do not wash the filter with water, this may cause filter blockages

Note: Replacing the filter every 3-months is recommended for maximum cleaning effectiveness

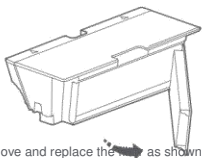

Remove and replace the filter as shown

Side brush * Clean monthly

1. Turn over the main unit and remove the fixing screw on the side brush
2. Remove and clean the side brush
3. Reinstall the side brush

Note: Replacing the side brush every 3-6 months is recommended for maximum cleaning effectiveness.

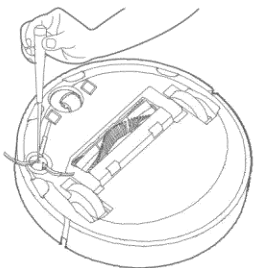

Battery

The product is equipped with a high-performance lithium-ion rechargeable battery. Keep the product charged for maximum battery performance.

Note: If to be left unused for a long period of time, fully charge the product and switch it off before storing it in a cool, dry place. Charge it at least every three months to avoid over discharging the battery

Omni-directional wheel *Clean monthly

1. Turn over the main unit and lift out the omni-directional wheel
2. Remove any hair and dirt on the wheel and axle
3. Reinstall the wheel

Note: Rinse wheel under the tap and reinstall when dry

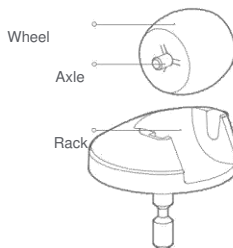

Routine Maintenance

Sensors * Clean monthly

Use soft dry cloth to wipe clean each sensor:

1. Four cliff sensors on the bottom
2. Infra-red deceleration sensor in the front
3. Charging contacts on the bottom

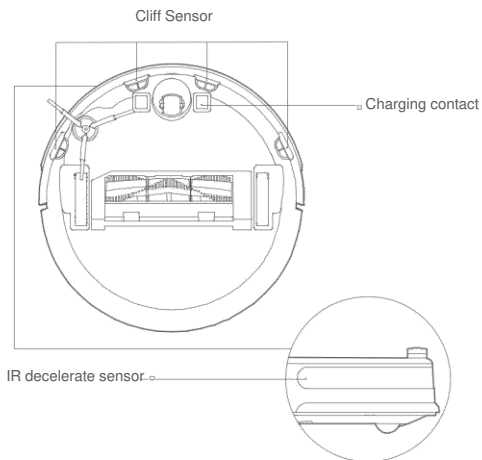

Charging dock * Clean monthly

Use soft dry cloth to clean the charging contacts on the charging dock

Firmware update

You can use the Mi Home app to for firmware updates. Connect the main unit to the dock charger and ensure that battery capacity is above 20% before updating. The power indicator will blink white rapidly during a firmware update

System reset

If pressing the buttons has no response or the main unit cannot be shut down, reset the system by pressing the  key. The main unit will restart automatically after reset

Restoring to Factory Defaults

If the product does not function properly after resetting, press and hold the   buttons simultaneously, until you hear "Start restoring the initial version." The product then be restored to factory defaults

Basic parameters

Main unit

Name	Specifications
Model	C1***** (* can be 0 to 9, A to Z, a to z, ".", "-", "=", "@", "#", "\$", "%", "&" or blank, for marketing purpose.)
Outline Dimensions	353x350x90.5mm
Battery	14.4V/2600mAh lithium battery
Weight	About 300g
Wireless connection	WiFi Smart Connect
Voltage rating	14.4VDC
Power rating	50W

Charging dock

Name	Specs
Model	CDZ03RR or CDZ04RR
Outline Dimension	151x130x98mm
Power rating	42W
Input rating	100-240VAC
Output rating	20VDC 1.8A
Frequency rating	50-60Hz

Xiaowa Model Comparison

	Xiaowa Lite	Xiaowa	Xiaowa Plus
Model (can be 0 to 9, A to Z, to z, "-", " ", " ", " ", " " or blank, for marketing purpose.)	Xiaowa C1 *****	Xiaowa E2 *****	Xiaowa E3 *****
Cleaning method			
Wet mopping function	No mopping	Sweeping + mopping	Sweeping + mopping
Navigation method	Adaptive random navigation	Inertial navigation route planning	Inertial navigation route planning
Automatic recharge	√	√	√
Cleaning capacity			
Obstacle clearance height	2.0cm	2.0cm	2.0cm
Max suction	1600Pa	1800Pa	2000Pa
Dust bin capacity	640 ml	640 ml	640 ml
Max run time	60 minutes	90 minutes	150 minutes
Battery capacity	2600mAh	2600mAh	5200mAh
Extended app functions			
Cleaning map	No map	Pixel map	Pixel map
Timer cleaning	√	√	√
Smart home interconnection	√	√	√
Carpet Boost	√	√	√
Hardware system			
Fall prevention	√	√	√
Washable strainer		√	√
Moistureproof mat		√	√

Troubleshooting

If an error occurs, the power indicator will flash red and a voice prompt will sound. Use the table below to resolve these errors

Fault display	Solution
Error 2: Please inspect the bumper	The bumper is stuck. Lightly tap it several times to dislodge any trapped material. If nothing is found, move the main unit to a new location and restart
Error 3: Please move the machine to a new location and start it	A wheel is stuck. Move the main unit to a new location and restart
Error 4: Cliff sensor error	The machine is stuck. Move it to a new location and restart. This error may also be caused by a dirty sensor. Check cliff sensors and wipe clean if necessary
Error 5: Please clean the main brush	Main brush may be entangled. Remove and clean it and its bearings
Error 6: Please clean the side brush	Side brush may be entangled. Remove and clean it
Error 7: Main wheel exception	The main wheel may be entangled. Remove and clean it then replace and restart the main unit
Error 8: The machine gets stuck	The main unit is stuck. Clear any obstacles around it
Error 9: Please reinstall the dust bin and strainer	Reinstall the dust bin and filter and check that they are installed properly. If the problem persists, replace the filter
Error 10: Please clean the strainer	The filter may be blocked. Clean it thoroughly. If the problem persists, replace the filter;
Error 11: High-intensity magnetic field detected	The main unit is too close to a virtual wall when starting up. Move it to a new location before starting

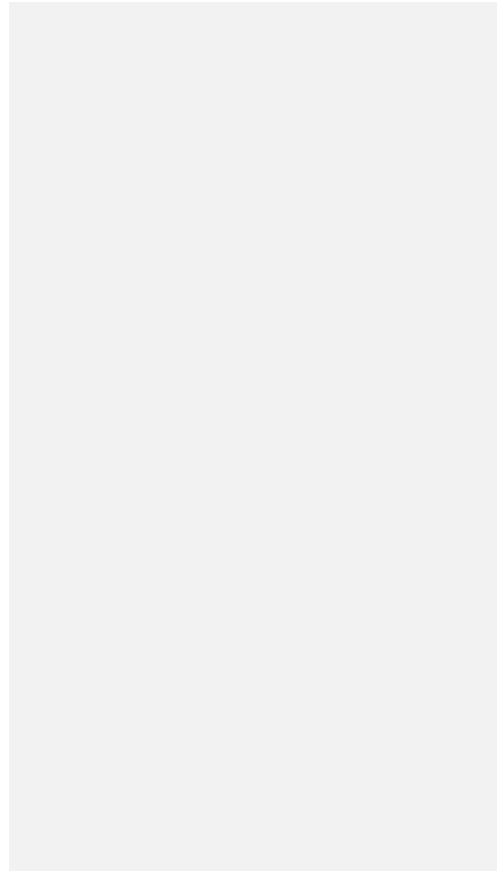

Troubleshooting

Error 12: Battery low	Battery low, charge it before use;
Error 13: Charging error	Use a dry cloth to wipe the charging contact points on the main unit and the charging dock
Error 14: Battery error	Battery temperature is too high or too low battery. Wait until the battery temperature returns to normal before use
Error 17: Side brush exception, please reset the system	The side brush module has malfunctioned. Reset the system
Error 18: Fan error, please reset the system	The dust collection fan has malfunctioned. Reset the system
Error 22: Please wipe the recharge sensor	The recharge sensor is blocked by dust. Wipe the dust off the sensor
Error 23: Dock charger signal error	The charging dock is blocked by dust other matter. Remove it;
Internal error, please reset the system	Internal error. Reset the system

Notes:

1. Resetting the system may partially eliminate exceptions
2. Error 1, error 15, error 16, error 19, error 20 and error 21 are error codes for other models and not applicable to this machine

If the problems persist after using the above recommendations, email our after-sales service teams:

US/Non-Europe Support: support@roborock.com

Europe Support: support@roborock-eu.com

带格式的: 法语(法国)

EU Declaration of Conformity

Hereby we:

Name of manufacturer	Beijing Roborock Technology Co.,Ltd.
Address	Floor6,Suite6016,6017,6018,BuildingC,Kangjian Baosheng Plaza,◆ No.8 Heiquan Road,Haidian District, Beijing,P.R.CHINA

declare that this DoC is issued under our sole responsibility and that the products:

Product description	Robotic Vacuum Cleaner and Accessories
Type(model) designation(s)	C1***** (* can be 0 to 9, A to Z, a to z, "-", " _", "!", " /" or blank, for marketing purpose.)

are in conformity and verified through testing with the provision of the following EU directives:

<p>RED Directive 2014/53/EU Article 3.1 a): Safety&Health 1. EN 60335-1:2012 + A11:2014 +AC:2014 + A13:2017 2. EN 60335-2-2:2010 + A11:2012 + A1:2013 3. 1999/519/EC 4. EN 62311:2008 5. EN 62233:2008</p>	<p>1.Household and similar electrical appliances-Safety-Part 1: General requirements 2.Household and similar electrical appliances-Safety-Part 2-2: Particular requirements for vacuum cleaners and water suction cleaning appliance 3.COUNCIL RECOMMENDATION of 12 July 1999 on the limitation of exposure of the general public to electromagnetic fields (0 Hz to 300 GHz) 4.Assessment of electronic and electrical equipment related to human exposure restrictions for electromagnetic fields (0 Hz - 300 GHz) 5.Measurement methods for electromagnetic fields of household appliance and similar apparatus with regard to human exposure</p>
--	--

EU Declaration of Conformity

<p>RED Directive 2014/53/EU Article 3.1 b): EMC</p> <ol style="list-style-type: none"> 1. Draft EN 301 489-1 V2.2.0 2. Draft EN 301 489-17 V3.2.0 3. EN 55014-1:2017 4. EN 55014-2: 2015 5. EN 61000-3-2: 2014 6. EN 61000-3-3: 2013 	<ol style="list-style-type: none"> 1. Electromagnetic Compatibility (EMC) standard for radio equipment and services; Part 1: Common technical requirements; Harmonized Standard covering the essential requirements of article 3.1(b) of Directive 2014/53/EU and the essential requirements of article 6 of Directive 2014/30/EU 2. Electromagnetic Compatibility (EMC) standard for radio equipment and services; Part 17: Specific conditions for Broadband Data Transmission Systems; Harmonized Standard covering the essential requirements of article 3.1(b) of Directive 2014/53/EU 3. Electromagnetic Compatibility-Requirements for household appliances, electric tools and similar apparatus Part 1: Emission 4. Electromagnetic compatibility – Requirements for household appliances, electric tools and similar apparatus Part 2: Immunity – Product family standard 5. Electromagnetic compatibility (EMC) - Part 3-2: Limits - Limits for harmonic current emissions (equipment input current ≤ 16 A per phase). 6. Electromagnetic compatibility (EMC) - Part 3-3: Limits - Limitation of voltage changes, voltage fluctuations and flicker in public low-voltage supply systems, for equipment with rated current ≤ 16 A per phase and not subject to conditional connection.
<p>RED Directive 2014/53/EU Article 3.2: Radio Spectrum EN 300 328 V2.1.1</p>	<p>Wideband transmission systems; Data transmission equipment operating in the 2,4 GHz ISM band and using wide band modulation techniques; Harmonized Standard covering the essential requirements of article 3.2 of Directive 2014/53/EU</p>
<p>ROHS Directive 2011/65/EU EN50581:2012</p>	<p>Technical documentation for the assessment of electrical and electronic products with respect to the restriction of hazardous substances</p>

<p>Product description</p>	<p>Dock Charger and Accessories</p>
<p>Type(model) designation(s)</p>	<p>Dock Charger, models: CDZ03RR or CDZ04RR.</p>

are in conformity and verified through testing with the provision of the following EU directives:

EU Declaration of Conformity

Low Voltage Directive 2014/35/EU 1. EN 60335-1:2012 + A11:2014 2. EN 60335-2-29:2004 + A2:2009 3. EN 62233:2008	1. Household and similar electrical appliances-Safety-Part 1: General requirements 2. Household and similar electrical appliances-Safety-Part 2-29: Particular requirements for battery chargers 3. Measurement methods for electromagnetic fields of household appliance and similar apparatus with regard to human exposure
EMC Directive 2014/30/EU 1. EN 55014-1:2017 2. EN 55014-2: 2015 3. EN 61000-3-2: 2014 4. EN 61000-3-3: 2013	1. Electromagnetic Compatibility-Requirements for household appliances, electric tools and similar apparatus Part 1: Emission 2. Electromagnetic compatibility – Requirements for household appliances, electric tools and similar apparatus Part 2: Immunity – Product family standard 3. Electromagnetic compatibility (EMC) - Part 3-2: Limits - Limits for harmonic current emissions (equipment input current ≤ 16 A per phase). 4. Electromagnetic compatibility (EMC) - Part 3-3: Limits - Limitation of voltage changes, voltage fluctuations and flicker in public low-voltage supply systems, for equipment with rated current ≤ 16 A per phase
ROHS Directive 2011/65/EU EN50581:2012	Technical documentation for the assessment of electrical and electronic products with respect to the restriction of hazardous substances

Person responsible for making this declaration:

Printed name: Rui.Shen

Position/Title: Quality Director

Signature: Rui.Shen.

Date of issue: Jun 14, 2018

WEEE Information

Correct Disposal of this product . This marking indicates that this product should not be disposed with other household wastes throughout the EU. To prevent possible harm to the environment or human health from uncontrolled waste disposal, recycle it responsibly to promote the sustainable reuse of material resources. To return your used device, please use the return and collection systems or contact the retailer where the product was purchased. They can take this product for environmental safe recycling.

Korrekte Entsorgung dieses Produkts Innerhalb der EU weist dieses Symbol darauf hin, dass dieses Produkt nicht über den Hausmüll entsorgt werden darf. Altgeräte enthalten wertvolle recyclingfähige Materialien, die einer Wiederverwertung zugeführt werden sollten und um der Umwelt bzw. der menschlichen Gesundheit nicht durch unkontrollierte Müllbeseitigung zu schaden. Bitte entsorgen Sie Altgeräte deshalb über geeignete Sammelsysteme oder senden Sie das Gerät zur Entsorgung an die Stelle, bei der Sie es gekauft haben. Diese wird dann das Gerät der stofflichen Verwertung zuführen.



Warranty Information

The seller provides warranty in accordance with the legislation of the customer's own country of residence, with a minimum of 1 year, starting from the date on which the appliance is sold to the end user.

The warranty only covers defects in material or workmanship.

The repairs under warranty may only be carried out by an authorized service centre. When making a claim under the warranty, the original bill of purchase (with purchase date) must be submitted.

The warranty will not apply in cases of:

Normal wear and tear

Incorrect use, e.g. overloading of the appliance, use of non-approved accessories Use of force, damage caused by external influences Damage caused by non-observance of the user manual, e.g. connection to an unsuitable mains supply or non-compliance with the installation instructions Partially or completely dismantled appliances



Robotic Vacuum Cleaner

Manufacturer: Beijing Roborock Technology Co., Ltd.

Product Model: C1***** (* can be 0 to 9, A to Z, a to z, "-", "_", "\", "/" or blank, for marketing purpose.)

Address of Manufacturer: Floor 6, Suite 6016, 6017, 6018, Building C, Kangjian Baosheng Plaza, No. 8 Heiquan Road, Haidian District, Beijing, P.R. CHINA

For more product information, please visit our website: www.roborock.com

For after-sales support, please email our after-sales service team:

USA/Non-Europe Support: support@roborock.com

Europe Support: support@roborock-eu.com

带格式的: 法语(法国)